

Grimm | *AUDIO*

LS1

DRIVEN TO IMPROVE

GRIMM AUDIO LS1

Congratulations on your purchase of the Grimm Audio LS1 playback system.

In this manual we like to assist you in setting up the LS1 playback system. You will learn how to connect various sources and how to control the electronics, the LS1r Controller and the LS1 remote software for Mac and PC. Furthermore we like to explain what makes the LS1 playback system so different from all other hifi speakers, why they look, function and most important sound the way they do. If you are about to unpack and assemble your LS1 set, please move forward to 'Assembly and Install' on page 14 of this manual.

Grimm Audio's LS1 was designed to show that one speaker can be both analytically precise and musically pleasing at the same time. When we developed the LS1, we had the professional user in mind. In a studio you need a speaker that is as linear as possible. 'Voicing', as the practice of tuning a loudspeakers' response by ear is called, only masks aberrations from linearity. The better way is to carefully measure the response with the best test gear available and use that as a guide. We tested the LS1 in a large anechoic room using a measurement microphone that we calibrated ourselves with a spark gap reference. In fact we perform part of these measurements as a standard routine during production, so the response of your LS1 loudspeakers has also been individually measured and corrected.

By integrating top quality digital signal processing, converters and amplifiers in one of the speakers' legs, we were able to apply technical strategies no one had used before. As a consequence, the LS1 is not just a loudspeaker, but a complete audio system that only needs an analog or digital line source to perform. CD players, phono stages, music servers or computers all connect straight to the speaker.

The correction of the measured response is done digitally in DSP ('Digital Signal Processing'). Digital processing offers a much higher degree of correction than possible in the analog domain, and without the distortion associated with analog components. Digital sources are fed directly into the DSP, in case you like to listen to an analog source we included a very high quality AD converter in the system. The DSP in the LS1 takes care of three important tasks: response correction of the drivers, cross-over between the drivers and phase correction of the cross-over. Let's look at the response correction first. And remarkably this means we first need to step back into the analog domain of acoustics. The spatial radiation behavior of a loudspeaker cannot be corrected electrically so it should be taken care of first.



The Acoustics

The theory behind the LS1's acoustical design originates back to the 1930s and '40s. Cabinets in those days were flat but wide, which moved the so called 'baffle-step' frequency to lower than 250 Hz. Below the baffle step frequency, sound is radiated equally in all directions. Above the baffle step the sound becomes more forward directed, thereby attenuating reflections against the wall behind the speaker and the side walls. These reflections normally cause phase errors in the perceived sound. Psycho acoustics says that the ear is sensitive to phase errors down to approximately 250 Hz. The wide baffle helps to attenuate interfering reflections throughout this whole range.

Progress since the 40's has learned that edge diffraction of the cabinet deteriorates the stereo image, hence the sides of the LS1 cabinet are strongly rounded by the legs. As a bonus, the shallow cabinet moves the resonance along the depth axis inside the box significantly above the cross-over frequency of the low frequency driver. This helps to avoid boxiness.

Next step in the design phase was the driver selection. We settled on an outstanding pair of Seas units. The tweeter's exceptionally low distortion in the mid range allows a fairly low cross-over frequency that benefits vertical dispersion. Its small constant directivity horn ensures an even spread of high frequency sound.

Even dispersion is also helped by the lack of cone breakup effects in the magnesium woofer below the crossover frequency. The woofer's long excursion permits generous sound pressure capability down to 40Hz for the two way configuration. Adding the LS1s subwoofer takes performance up a notch by extending the response down to 20 Hz and further increasing attainable loudness.

The Electronics

With an acoustically optimised response as a starting point, we applied DSP equalisation to flatten the response of woofer and tweeter. Thanks to the cabinet design only a few minimum phase IIR corrections with low Q were necessary to linearize amplitude- and phase response. Correction and cross-over were adjusted by hand, based on a multitude of measurements in an anechoic environment. Driver errors need to be treated differently from cabinet diffractions and automatic algorithms are unable to distinguish between the two kinds. Finally, the acoustic sum was phase corrected to minimum phase which avoids the pre-echos introduced by more common linear phase corrections. Measurements of the step response confirm the effectivity of this strategy.

When adding the LS1s subwoofer an LS1 turns into a true three-way system. The DSP again takes care of all filtering, including the cross-over and its phase correction which has dramatic impact at low frequencies. A three-way system has never sounded so even as this. Just like with the two-way system our DSP correction offers a freely configurable low cut frequency. Usually the two-way is cut off at 40 Hz and the three way at 20 Hz.

Digital input signals are re-clocked by a state of the art ASRC circuit which is based on the same oscillator as the legendary Grimm CC1 clock. Analog inputs are first converted to digital with a high performance A/D converter. The signal then enters the DSP, which has a data path of 48 bits wide with a 76-bit accumulator. Each driver then has its own high quality D/A-converter. The output of the D/A converters is directly fed into 120 W Hypex Ncore power amplifiers. The optional LS1s subs have an additional 400 W amp each. Hypex Ncore power amplifiers have the lowest harmonic distortion on the market and are the perfect choice for the LS1 due to their linearity and excellent transient response. Throughout the whole circuit, careful attention has been paid to component selection like capacitors and resistors. Critical parts such as power supply regulators are of our own discrete design. Once our circuits measure well, we start listening to tweak the last parts by ear.

And this explains why the LS1 is not only neutral and precise but also a joy to listen to and musically pleasing. We started with smart concepts and measurements but we did not stop there. We listened. And doing so we developed a loudspeaker system that is equally at home in a studio as well as in a living room. The LS1 is a true step forward into the 21st century.

Room Acoustics

Keep in mind that one always hears the loudspeaker plus its acoustic environment. Although the LS1 has superior acoustical characteristics, positioning it correctly in your room remains of great importance. Let's first have a brief look at room acoustics and then see how positioning the LS1 influences them.

Roughly speaking there are three factors in acoustics that influence the audible performance of a loudspeaker: first reflections, low frequency coupling of nearby walls and room modes (or room resonances). Lateral first reflections influence the stereo image. Since high frequencies are dominant in acoustic imaging, adding fabric acoustic absorption like curtains at the reflection spots on the left and right walls helps a lot. Since the LS1 has a wide baffle, aiming the loudspeaker away from the reflective spot helps too. Another major type of reflection is via the floor and ceiling. These reflections interfere less with the stereo image, but do color the sound. Absorbing the floor bounce with a carpet helps. A special case is reflections against an obstacle in front of the listener, like a computer screen, bouncing the sound toward the front wall and from there back to the listener. In those cases, absorbing the reflection at either the obstacle or the wall cures the problem. Due to the wide baffle of the LS1, which focusses the sound, reflections on the wall behind the listener tend to have slightly more impact than with other loudspeakers. Please consider to add absorption or sound scattering objects like bookcases against this wall.

First reflections also introduce phase distortion in the early sound if the walls are too close. Psycho acoustics tells us this effect is important down to 250 Hz. One wavelength of a 250Hz tone lasts 4ms so this is the time span that certainly needs to be 'clean'. Sound travels app. 1.4 m in that time. Rules of thumb are therefore that you need to have at least 80cm distance from the side walls (1.5 m is better) and 60cm from the back wall (1.2m is better). The wide baffle of the LS1 makes the distance to the wall behind them less critical, but if you have the chance, please allow for some distance. An alternative is to choose the other extreme and place each LS1 with the back directly against a wall. In that case all reflections from the back wall integrate completely in phase with the direct sound, the speaker gets an 'infinite baffle'. Unfortunately the speakers can not be aimed inwards in this setting to optimize the stereo image, unless the walls have the right angle of course.

This brings us to low frequency coupling of nearby walls. Below 250 Hz the LS1 radiates

sound in all directions and sound travelling backwards and sideways reflects against the walls and adds up to the direct sound. Although the ear is less sensitive to the resulting phase errors at these low frequencies, the impact on the low frequency energy itself can be dramatic since at certain frequencies the reflected sound can cancel the direct sound. A real solution is to apply low frequency absorption behind the loudspeaker so the reflection is attenuated. Those who cannot afford such measures are invited to spend some time shifting the speakers back and forth until the optimal compromise is found. In this respect the LS1 is not different from any other loudspeaker. A special feature of the LS1 however is that the LS1's subwoofer can be taken off the foot plate of the main system so both can be positioned independently. If your room acoustics are particularly difficult, feel free to experiment with placing the sub closer to the wall than the main speaker. You can use the parameters in the subwoofer preference pane (Gain and Delay) to compensate resulting alignment errors. Please read the chapter 'Software Control Settings' for more information.

An annoying asset of most rooms is that they resonate at low frequencies (below 200 Hz). Tones bouncing back and forth between walls interfere, and at certain frequencies they form node and anti node patterns which means that certain tones sound silent in one place in the room but are very loud at other spots. These resonances are called room modes and since they are dependent on the dimensions and the weight of the walls, they vary from room to room. Some rooms therefore sound 'better' than others. Whether a certain room mode is triggered or not is dependent on the position of the source and of the listener. So again, it makes sense to spend some time positioning the LS1's carefully to find the optimal compromise. Consult a specialized acoustician if you have a real strong room mode problem in your room.

Some companies apply DSP for 'room correction'. We rather not use DSP in the LS1 for this since the effects are influenced by the position of the listener. If we again look at the three acoustic factors: 1. First reflections are strongly dependent on the listeners' position, so there is no way to correct these with DSP. This is certainly true above 200 Hz where the wavelength is short. 2. The low frequency coupling effect can partly be compensated by DSP (please use the LS1 EQ for that). However in the region around 100 Hz where often energy is lowered due to the reflection being out of phase, DSP will not help since a louder tone will still be canceled by its reflection. 3. Finally, room modes are also strongly dependent on the position of the listener. Theoretically it should be advantageous to attenuate peaks in the room response that reside in the whole listening area, but all DSP solutions for this we tried so far challenged the LS1's performance too much.

LS1 Setup

Correct placement of your loudspeakers is essential for achieving the ultimate goal of reproducing the music as it was intended by the artists. During production in the studio the producer listened in a so called 'equal triangle' setup where the corners of the triangle between the two loudspeakers and the listener are all 60 degrees. When possible, please try to reach this arrangement. The distance between the loudspeakers ideally is between 2.5 and 3m.

It is necessary to make sure that both the left and right loudspeaker have a similar acoustical environment. For example, if one loudspeaker is placed close to a side wall and the other has free space on its side, the sound of the speaker against the wall will be enforced by reflections and therefore the stereo image shifts to that side. A quick and easy check is to sit at the listening position and have an assistant talk to you from both speaker positions. If his voice sounds equal in both positions, you are fine. If he is boomy in one position and bright in the other, better search further for better positioning. Listen to both the sound of the direct sound from the assistant and of the 'room sound'. In fact, strange as it may seem, you can hear these effects too when speaking yourself at the loudspeaker positions. If you cannot find equal sounding positions for the loudspeakers in your room, and for instance one speaker has to stand in a corner and the other just a long a wall, you may use the LS1 EQ to equalize a difference in the low end between both speakers. Please consult the EQ paragraph of the Software Control Settings chapter in this manual.

The LS1 cabinet is wider than usual, so the effect of turning the loudspeaker around its vertical axis is larger than you would expect. The off-axis response on the front side of the LS1 is extremely even (the LS1 sounds just as good slightly off-axis as on-axis), but it becomes gradually softer when the angle is larger. We can use this to our advantage. In the classic arrangement the loudspeakers face the listener. The angle of the loudspeakers relative to the wall behind them is 30 degrees. The superb off-axis performance of the LS1 offers an alternative setup where both loudspeakers are turned slightly further inward, or 'toe in'. We advice an angle to the wall of 45 degrees. The listener then sits at 15 degrees off-axis of the loudspeakers. This 'toe in' setup has two advantages:

- 1.** For seats left or right of the sweet spot, the stereo image is better preserved. The reason is that for a left seat the sound of the left loudspeaker will reach the ear more early. This causes a shift to the left in the stereo image. But at the same time, the listener is more on-axis of the right speaker and more off-axis of the left speaker. The right loud-

speaker therefore becomes slightly louder and the image shifts back to the right again. It is not perfect, but the net effect is a wider area to enjoy a nice stereo image.

- 2.** The reflection of the left loudspeakers' sound to the left wall and vice versa becomes attenuated a bit. Since this reflection path is usually relatively short, it needs to be attenuated to not interfere with the stereo image. An easy trick to check if this reflection is too loud is to listen to a mono sound on one loudspeaker only. Close your eyes and point in the direction of the sound. Now open your eyes again and look at your finger. If it is pointing towards the center of the loudspeaker everything is fine. If you point a little bit off-center in the direction of the wall, the reflection is too loud. If turning the LS1's toe-in does not cure the problem, you will need to apply acoustic absorption at the reflective spots. Mark that by turning the left LS1 like this, its reflection on the right wall will become relatively louder. Usually this is not a problem but rather an advantage because this reflection comes later. Psycho acoustics says it helps the brain to extract the 'ambience' information from the recording.

In about 20% of the rooms, the classic setup where the LS1's face the listener still sounds better. This is usually the case in fairly large rooms or in rooms with acoustics where left and right reflections are very well balanced. Please accept this as an invitation to experiment and listen in your own environment.

Once you have decided on which of the two setups sounds best, please run the LS1 remote software and set the 'toe in' angle in the preferences to your selected 45 degrees or 30 degrees angle. This applies a small correction to the highest treble, making sure the frequency response of the direct sound is perfectly linear at the listening position.

LS1s - the optional Low Frequency Extension

With some kinds of music at higher playback levels, sufficient acoustic power in the low frequency range is required for high fidelity playback. In many cases the standard 2-way configuration will be able to deliver the full range at a sufficiently high level, because of the generally limited amount of ultra-low frequency sound in most music.

The software control settings in the 'LS1' tab of the preferences allows the user to set a 'Low-cut frequency'. If that is set to 40-45Hz the LS1 can produce impressive levels, even as a 2-way system. If you set the low-cut frequency down to 35Hz or even 28Hz the LS1 will still stay completely linear, only the maximum achievable sound level becomes lower.

With large church organs or modern music with non-acoustic electronic instruments the content at frequencies below 40 Hz can, however, become significant and a little help from a big 'woofer' would be required to play at higher sound levels. So we developed the 'LS1s' low frequency extension.

Normally the reproduction of very low frequencies demands for a large driver, because for physics reasons more air has to be moved for the same amount of sound as at high frequencies. Unfortunately a large driver needs a large cabinet in order to not limit the lowest frequency, when no other means are available to correct this. We wanted the



additional woofer to be both acoustically and visually integrated, which did not allow for a large cabinet. So the challenge was to reach a high SPL level at low frequencies, while at the same time retaining a perfectly flat frequency, time and phase response down to very low frequencies, without a large cabinet.

Fortunately, the same DSP controller that ensures the flawless combination of the tweeter and woofer with perfect timing and frequency behaviour can also be used to overcome the issues that arise when adding an additional 'sub'-woofer for the ultra-low frequencies. By selecting a moderately large high performance driver with a very long linear excursion, sufficient air can be moved and the DSP in combination with a powerful 400W amplifier compensates the frequency limitation due to the mounting in a small cabinet.

The LS1 's have a dedicated subwoofer output, which can be controlled from within the remote software. It is possible to connect any subwoofer to this output, using a standard setting without phase compensation because standard subwoofers are designed to act as standalone units. The optional LS1s low frequency extension adds something more and provides full integration with the LS1 itself. With the LS1s added, the LS1 effectively becomes a 3-way speaker system with perfect time and frequency alignment.

Switching to the 'Grimm Sub' setting in the preferences sets a dedicated crossover, time and phase correction preset in the DSP, so the system becomes a perfectly matched 3-way speaker and not only a 2-way with an added subwoofer. It completely retains and even stretches its phase and time coherence as well as a linearized frequency response over the full frequency range down to 20Hz. The woofer of the LS1 becomes a mid-only unit that is crossed over to the subwoofer at ca. 70Hz, and is now able to handle higher levels of sound.

The result is that the LS1 sounds nearly identical, both as a 2-way or a 3-way system. The main difference is the higher possible sound pressure level and a powerful low frequency extension down to 20 Hz. Also, distortion in the low frequency range has dropped a bit.

Unpacking And Assembly



If you are ready to assemble your pair of LS1's, please first make yourself familiar with all components in the box.

The open transport package should look somewhat like in the pictures on the left. First take out the 'accessory box', the CAT5 cables, both speaker cabinets and the extruded aluminium profiles, which for simplicity from here on shall be called 'legs'.

The next step is to unscrew the footplates from the transport package, but be careful as those are really heavy.

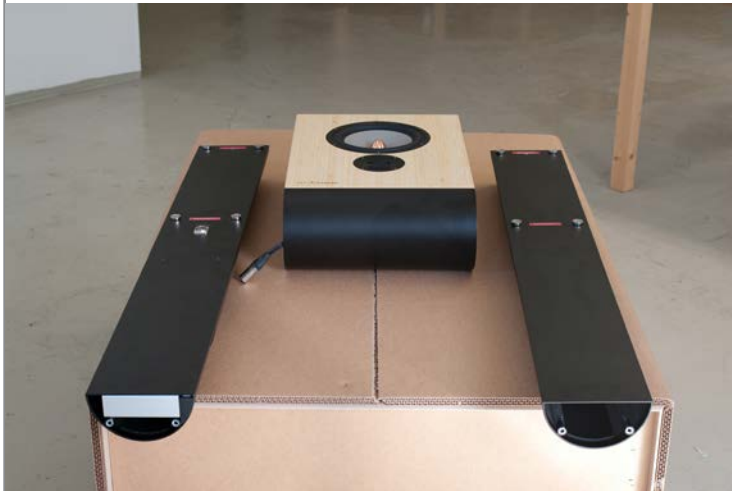

Take a speaker cabinet and lay it down on the empty and closed shipping crate or on a big, clean table, with the drivers facing up. Place two of the legs next to it, one with and one without electronics.

Normally, when setting up in a living room, you'll prefer the electronics panel facing to the back side of the speaker in order to look uncluttered. In this case put the 'active leg' on the left side, next to the speaker cabinet on the table, the other leg to the right side. If for some reason you want the electronics to face the front side of the speakers, you can simply swap the legs.

The multipin connector that is used to connect the speaker cabinet to the electronics contained in the leg can be pulled out of either side of the bottom aluminium profile attached to the cabinet. So the choice is yours, where to place the 'active leg'.

Plug the cable connector into the chassis connector of the leg.

Very Important:

Every speaker is individually measured and tuned during manufacturing, the unique correction curve for this speaker is then stored in the DSP of the matching electronics.

Therefore both parts, speaker and electronics, get the same serial number.

Please always make sure you assemble the matching electronics with its proper speaker.

Unpacking And Assembly



Put both legs flush with the cabinet on the table, until the four magnets have snapped onto the metal sides of the speaker cabinet.

Please be careful, these are very strong magnets. Keep them far from anything sensitive to magnetic fields.

Please secure the connection of the legs and cabinet by fitting the knurled screws (found in the 'accessory box') on the top part of the inside of the legs.

Screw them in, but don't tighten them completely yet, so we can still align all the edges exactly by hand later on, once the LS1 are in place, because we also want them to look good...



Unpacking And Assembly

From now on it is really helpful and recommended to have a second person to help you setting up the speakers.

The footplate is mounted with the four hexagon socket screws found in the 'accessory box' (as is the matching Allen key).

Please only tighten those gently, there is no need to torque them down too hard.





Unpacking And Assembly

Now you can carefully set the assembled LS1 upright. As mentioned asking a second person to help you is highly recommended.

Best is to directly place the LS1 close to the right spot in the room. If you are on your own, the easiest way to carry the speaker is to stand behind it and grab it underneath the bottom profile of the cabinet with both hands.

With two people the easiest way to carry the LS1 is to stand next to both sides of the speaker and grab it underneath the bottom cabinet profile from front and back. This way it is pretty easy to move the speaker to it's desired location.

If the edges of the cabinet and the leg don't align perfectly you can now untighten the knurled screw inside the leg just a little bit and align all edges carefully by hand. The strong magnets provide a secure fit of the legs to the cabinets, while still allowing tiny adjustments in all directions to make them a perfect fit. If you are done aligning the cabinet and legs, gently tighten the knurled screws. Again there's no need to torque them down too hard.

The next step is to put the covers on top of the legs, these are only held in place by magnets and can also be aligned simply by hand.

These steps can now be repeated to assemble the second speaker. In the next chapter we will have a look at all the connections and peripherals. If you like to start wiring your system right away, please jump to the 'Connectivity' chapter of this manual.



Internal flow diagram of LS1

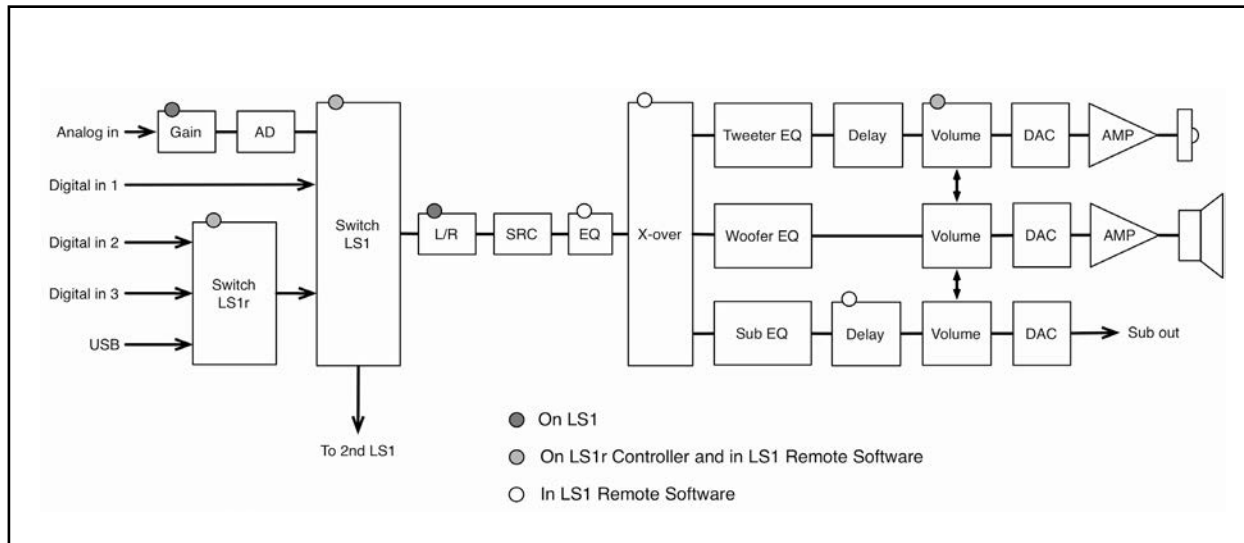

The LS1 is not just a speaker but a complete playback system. On the left page you see a flow diagram that illustrates the various internal processes. First there are switches that select a signal from the various sources. Some sources are connected directly to the LS1, some to the LS1r Controller box. Then follows a switch that determines whether the LS1 plays back the left or right channel of a digital stereo pair. Next is a sample rate converter so our DSP can always linearize the speaker up till very high frequencies, and then there's an equalizer. The crossover splits the audio range in two or three bands, dependent on the settings. What follows are EQ's for the various drivers (individually calibrated during production) and a delay to compensate for the acoustic source position of the tweeter and the woofer. Just before the DAC there's a digital volume control. This is the best place for digital volume control in a system, since all processing now takes place before the volume control at maximum resolution.

Many settings of the LS1 can be controlled by the user. The dark dots in the diagram indicate the two parameters that can be set on the LS1 itself. The grey dots are functions that can be controlled by the LS1r Controller box or the LS1 Remote Software. The functions with the white dots can be set in the LS1 Remote Software. Let's first look at the controls on the LS1 itself.

Input Sensitivity (input sens)

This switch controls the input sensitivity of the analog input for each speaker between +4dBu and +19dBu in 1dB steps. The remote software can read and display the position of this switch, please refer to the chapter 'Software Control Settings'.

The position of this switch has no influence whatsoever on the digital inputs.

Channel Switch (Chnl)

If a digital input is used, and when the LS1 Remote software does not run, this switch selects if the left or right channel of the stereo aes/spdif-signal is played back on the speaker.

Attention: The settings of the LS1 Remote software always have the first priority. However, as soon as you use the speakers without the remote software, they will use the setting of the hardware switch again to determine the channel to play. For that reason it is advised to always put the switch in the right position.



Input sensitivity Channel switch



As we know already the LS1 is more than a speaker, it's actually a complete playback system with amplifiers, converters, volume control and source selection.

These are the sources that you can connect to the LS1 system:

- 1) Computer (Mac or PC) connected via USB
- 2) Analog Input *(for any analog source, this can e.g. be a phono stage, a tuner or even a tape machine)*
- 3) Digital Input 1 *(directly on one of the speakers) via AES/EBU or S/PDIF (these can e.g. be a CD-transport or a streaming client)*
- 4) Digital Input 2 + 3 *(located on the back of the LS1r Controller) via AES/EBU or S/PDIF*

This means you can have all possible kinds of audio sources permanently connected. Switching between the sources can be done via the remote software (-> see next chapter) or via the LS1 Controller that is included in the hi-fi package.

This is not only convenient, it completely eliminates the need for a classic hifi-preamp in the system.

It is well known that sometimes 'classical' hifi components don't match perfectly, impedance matching can be wrong, people try all sorts of cables and combine preamps, amplifiers and speakers of different brands searching for 'the magic combination'.

In the LS1 we do the opposite, the signal path is as short and pure as possible and all elements of the system are selected for an optimal joined performance. This way all coloration is minimized.

What's left in the end is what you put into the system: the music.



Let's have a closer look at the functions of the LS1r Controller.

The display on the front panel shows either the volume level, an activated MUTE (or DIM) mode or the respective input source while switching sources.

On top of the box you find a big dial that controls three functions:

1. Volume Control

If you turn the dial clockwise the volume is raised, if you turn it counterclockwise the volume is attenuated.

2. MUTE or DIM function

By shortly pressing the dial you can activate the mute or dim function (chosen in the software settings), by pressing it again the mode is deactivated. The preferences of the remote software allow the choice for either a complete mute of the signal, a dim (attenuation) of the signal by 10dB or a dim of the signal by 20dB. The dim function can be handy if you want to talk or answer the phone for example, while playback of the music continuous in the background.

3. Switching between input sources

If you press and hold the dial and then turn it clockwise or counterclockwise, you can change the source. The display indicates which of the input sources is selected. When the source you want to listen to shows up in the display, simply release the knob and the input source is now selected.

-> The Grimm Audio LS1r Controller has an infrared sensor. So any universal IR-remote can be used to remotely control these three functions! Please learn how to program your remote on the next page.

Programming the LS1r Controller / IR Remote

Some features of your LS1r Controller can be adjusted to suit your preference. The LS1r Controller also has the ability to learn infrared commands from all kinds of **handheld IR remotes** to control various settings. This means you can use a remote control you already own from another product to control the LS1r Controller. Supported IR formats include RC5, RC6 and Sony protocol.

IR controllable settings are **volume**, **input source selection**, and **mute**.

To program the LS1r Controller, press and hold the large dial. You will see three dots appear while you wait until the display briefly shows 'ESE' (which stands for 'Extra Settings'). Now you are in programming mode and you can release the dial. The display will show the control to be programmed.

The first control is 'brt' or the brightness of the display. Alternating it shows the current setting. By turning the dial you can change this setting.

The next menu item is selected by pressing the dial once more. You will then see 'CAL'. This calibrates the 0.0 volume point of the LS1 remote. If you turn the dial clockwise it shows 'SEt', meaning it has set the 0.0 point to the current playback volume level. If you turn the dial counterclockwise, the 'dEF' indication tells you the 0.0 reference point has been set back to its default position.

By pressing the dial one more time you will see a 'P' in the display, informing you that you are now in 'Programming' mode and the device is waiting to receive commands from your IR handheld remote.

You can step through the available controls by turning the dial.

Volume up:	U^
Volume down:	U_
Volume mute:	U-
Channel up:	[^
Channel down:	[_

When a control is on the display, just press the button on your handheld remote control that you want assign it to. If the transmitted format of your remote control is accepted, 'PPP' will show in the display. This means the command is stored and linked to the IR handheld remote button. You can repeat this action for the other controls, and also for the same control to overwrite it. When a received code is already in use for another function, the display will show 'P--' and the command is not stored. This is to prevent double use of codes.

In the IR programming mode, you can again go to the next setting by pressing the dial briefly. This setting shows 'bUtE' and lets you select the 'press' function for the 'button' (dial): either mute ('---') or dim ('-d-').

Next setting after pressing the dial is 'dIS' or 'display'. The options here are: 'uOL', 'oFF' and 'inP', which means you can choose if you want your display to show the 'volume', be 'off' or show the 'input', when you are not actively using it.

Pressing the dial now moves you to the next and last setting, which is a display of the software version of the LS1r Controller. '5U5' for instance means 'Software Version 6'. If you turn the dial in this menu you give a 'Factory Reset' and the display shows 'FrE'. If you instead press the dial once more, you will be back at the first 'brightness' setting.

You can always leave the programming mode of the LS1r Controller by pressing and holding the dial. You will see three dots appear and when all dots are lit, the display turns back to normal mode again, briefly showing the 'ESE' message.



The LS1 Remote software is designed to control all settings of the LS1 via the LS1i USB interface. You will use it during first setup of the LS1 system and whenever you like to make changes to the setup. Additionally it works as a fully functional remote control of the LS1's main parameters, such as volume and source selection. You can use it in stead of or next to an LS1r Controller.

Please download the LS1 Remote software for your mac, windows or linux PC from <http://www.grimmaudio.com/info/downloads/> and install the software following your standard procedure. To keep your system up to date, please enable the option 'Check for update on startup' in the Tools menu of the LS1 remote software.

Let's have a look at the functions of the remote software one by one, starting at the top:

(-> for hifi use, please make sure to deselect the option 'Advanced Studio Monitor Controls' from the 'Tools' menu. The display will then look like in the picture)

1. These buttons let you select an input source.
2. Here the current volume setting is displayed numerically. If you have a LS1r Controller in the system, its display will show the same level.
3. Below the volume setting you find an indication of the current status: whether the LS1 remote software has established a connection to your LS1 loudspeakers or not. In case the display shows the text 'offline', the speakers are not turned on or some part of the wiring is not in place, such as the loopback connector.
4. This is the volume dial that you can use to set your preferred listening level. You may also use the up and down arrows of your keyboard to increase or decrease the volume in small steps or the page up and down arrows for large ones. If available you can use the scroll wheel of your mouse to adjust the volume, when hovering above the volume dial.
5. The Mute button mutes the incoming signal. Pressing the button again deactivates the mute function. You may also use the space bar of the keyboard to mute or un-mute the LS1.
6. The Settings button offers access to the LS1 preference window.
7. A click on the EQ button opens the EQ tab of the preference window. The button also indicates whether the EQ of the LS1 is set to flat or not. If the EQ is not flat, the system is adjusted to taste and may not be linear anymore. In this case EQ button looks like being 'on'.



Advanced Studio Monitor Controls

The main display offers a second mode in which more functions are visible. These functions are in general only useful for professional audio engineers. This mode is engaged by selecting the option 'Advanced Studio Monitor Controls' from the 'Tools' menu. The functions of the main screen will then be as follows:

1. These buttons let you select an input source.
2. Here the current volume setting is displayed numerically. If you have a LS1r Controller in the system, its display will show the same level.
3. Below the volume setting you find an indication of the current status: whether the LS1 remote software has established a connection to your LS1 loudspeakers or not. If the display shows the text 'offline', the speakers are not turned on or some part of the wiring is not in place.
4. This is the volume dial that is used to set your preferred listening level. You can use the scroll wheel of your mouse to adjust the volume, when hovering above the volume dial. You may also use the up and down arrows of your keyboard to increase or decrease the volume.
5. The two buttons 'Ref 1' and 'Ref 2' offer alternative '0 dB' points for the display. This can help you to easily get back to your standard monitor level. The factory default setting for 0 dB in both reference levels is 79 dBC for a -20 dBFSrms pink noise signal, which is defined as 'K14' by mastering engineer Bob Katz. The reference levels can be adjusted to your acoustics or set to your own preference via the 'Tools' menu of the remote software. First set the volume at the intended acoustical reference level and then select 'Current level to Ref 1' or 'Current level to Ref 2' from the dropdown menu. You can also use the indicated keyboard short cut. Alternatively, the reference levels can be set on the 'Pro Settings' tab of the Settings window, and here you will also find a 'restore default' knob. To quickly set the volume control to 0 dB, either select 'Set volume to 0 dB Ref 1' (or 'Set volume to 0 dB Ref 2') from the Tools menu, or use the indicated keyboard shortcuts. You may also double click on the 'Ref 1' or 'Ref 2' buttons in the control window.
6. The Settings button offers access to the LS1 preference window.
7. A click on the EQ button opens the EQ tab of the preference window. The button also indicates whether the EQ of the LS1 is set to flat or not. If the EQ is not flat, the system is adjusted to taste and may not be linear anymore. In this case EQ button looks like being 'on'.



8. This button mutes both channels. Pressing the button again deactivates the mute function. You may also use the space bar of the keyboard to mute or un-mute the LS1.

9. Mute L and Mute R will mute either the left or right channel. They toggle with each other and with the large mute button. By clicking on the active button, the mute is deactivated again.

10. The Dim button lowers the signal level, until it is deactivated by pressing the button once again. The signal can be attenuated by either 10dB or 20dB, which can be set in the Settings window. A mouse-over pop up help indicates the current setting.

11. The Zoom button raises the signal by 20dB to check for hums and buzzes. Pressing it again deactivates the function and brings the signal back down. To avoid the risk of blowing your speakers, a limiter is engaged when the zoom function is on. If you play music when using the zoom function, an attenuated and distorted sound will be heard. This is normal. Use Zoom only for checking very low level sounds.

12. The Mono function sums both sides of the stereo signal into one mono signal, which is then played back on both speakers. If you want to listen to a 'real' mono source, you can additionally press either the 'Mute L' or 'Mute R' button and mute one of the speakers. You will now hear both sides of the stereosignal mixed and played back on one speaker.

(-> This function offers a great tool while setting up your LS1's. Listen to the mono sum of your music in turn on the left and right speaker and move your loudspeakers until both sound identical.)

13. The S (for Side) function calculates the difference between the left and right signals and plays them on both speakers. This is a very useful tool for checking the stereo content during recording or mixing and for monitoring MS processing during mastering.

14. The swap button swaps the left and right speaker channels, a trick used by mixing engineers to temporarily have a fresh look on the stereo balance of the mix. If the left and right speakers are physically reversed and you want to permanently swap them, please do not use this swap button but check out the 'Remote Connection' setting in the LS1 tab of the Settings window instead.

15. The Sim function activates a digital simulation of either a ported speaker system or a small box shelf type speaker, which can be set in the preferences. This can help the audio engineer determine how a mix 'translates' to other types of speaker systems. For your home listening pleasure you want to make sure that this button is turned off!

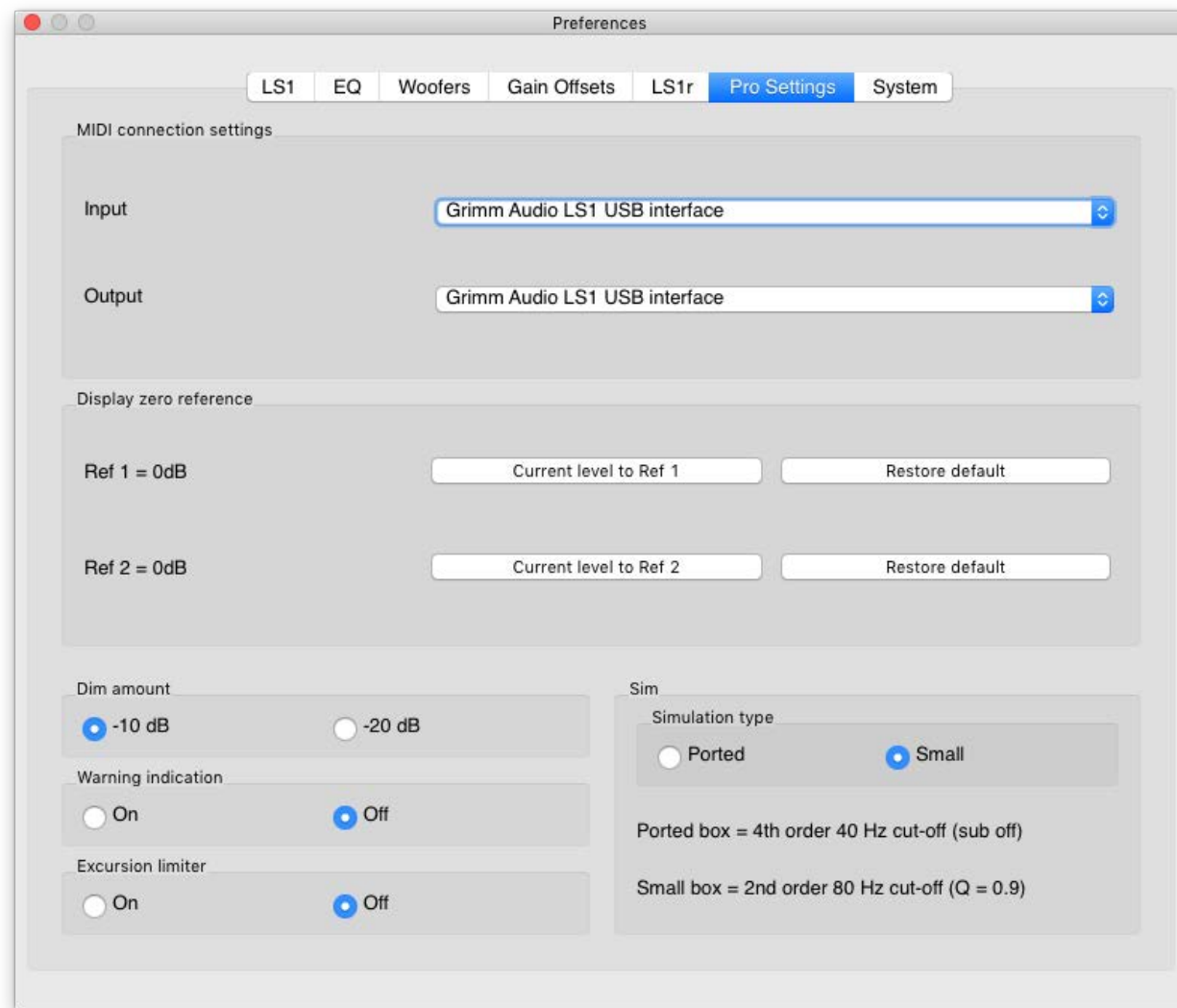

PREFERENCES

When setting up the LS1 system for the first time, please check out the preferences or 'Settings' window of the LS1 remote software. It offers easy access to the settings of all LS1 parameters. Some functions may need occasional adjustment, so you may like to have a look at the settings once in a while.

You open the preferences by clicking on the 'Settings' button in the main screen of the LS1-remote, or by choosing 'Preferences' from the menu.

The settings are spread over seven pages, that offer access to different parts of the system. These pages are:

LS1 / EQ / Woofers / Gain Offsets / LS1r / Pro Settings / System

Let's start with **Pro Settings** for a quick check whether the PC or Mac recognizes the LS1 USB interface. In the 'Midi connection settings' the LS1 USB interface should automatically be selected if the LS1i USB interface is connected and the LS1's are turned on. If not, please use the dropdown menu to select the 'Grimm Audio USB interface' for both the input and output. We will get back to the Pro Settings page later.

Saving presets

You can save all the LS1 preferences in a 'Preset' file on your computer or on a memory stick. This can be helpful when several people work on one LS1 system or when you like to bring your settings to a friend who also owns an LS1 system. To save the preferences, select 'save preset' or 'load preset' from the main 'File' menu.

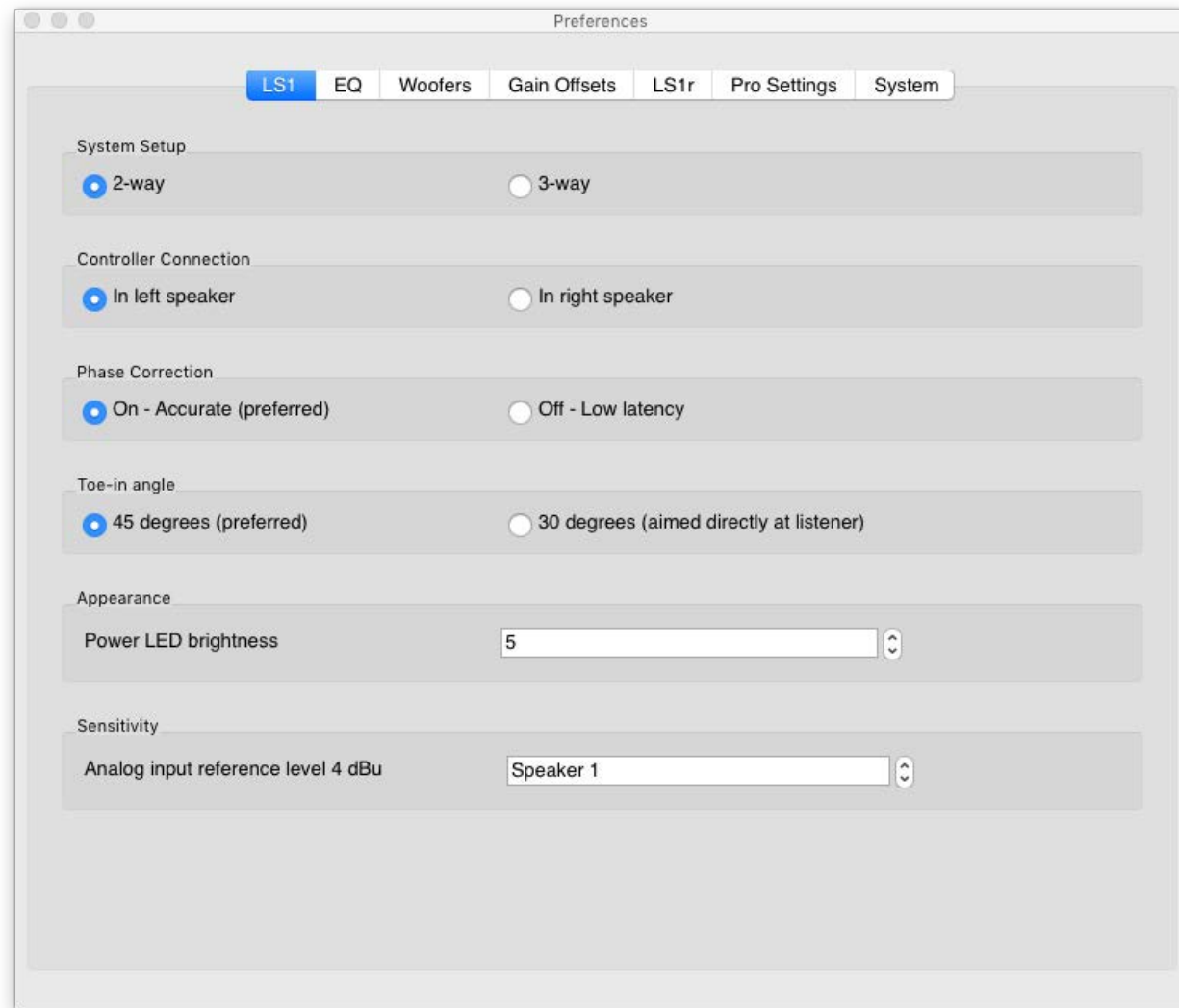

To perform your initial LS1 setup, please have a look at the **LS1** page. We will guide you through all settings here. Most settings are stored in the LS1 and the remote as soon as you change them. Only if you want an EQ preset to stay active when quitting the software you need to press a 'save in LS1' button.

System Setup - Please select whether you have installed a 2-way or 3-way LS1 system.

Remote Connection - Here you can indicate if the LS1 remote is connected to the left LS1 or the right LS1. By doing so, you determine which speaker will be playing the left channel and which speaker the right channel. Mark that digital audio cables, as used in the LS1, carry both the left and right channel, so you need to tell each speaker which channel to use.

Attention: at the speakers' base, next to the connectors, there's a switch called 'Channel Switch' (Chnl) that controls the left/right identity of the speaker when the software is not running. Please make sure the switch is set correctly. More information can be found in the Hardware Control Settings chapter of this manual.

Phase Correction - The crossover of the LS1 is phase corrected, which means both the amplitude and phase curve of the total response are linear. In other words: it means the magnitude and timing of the reproduced music is independent of the frequency. This is a unique feature, not possible with analog crossovers. The phase compensation introduces a small delay (or 'latency'), which is longer in the 3-way than in the 2-way system. In normal hifi and professional use, this delay is no problem and the preferred setting is 'Phase Correction - On'. The delay can be troublesome however (especially the longer delay of the 3-way system) in case you use the LS1 in the following cases:

- sound with pictures with an AV receiver that has no means to correct for the relative long latency of the speakers;
- when using both 2-way and 3-way LS1's in one surround system;
- when LS1's are combined with other brand's speakers in a surround setup;
- when using the LS1 as a live monitor for an artist playing in the control room.

In case the latency cannot be compensated for elsewhere in your system, you can turn off the phase correction and its associated latency in this pane.

LS1 setup with 45° angle

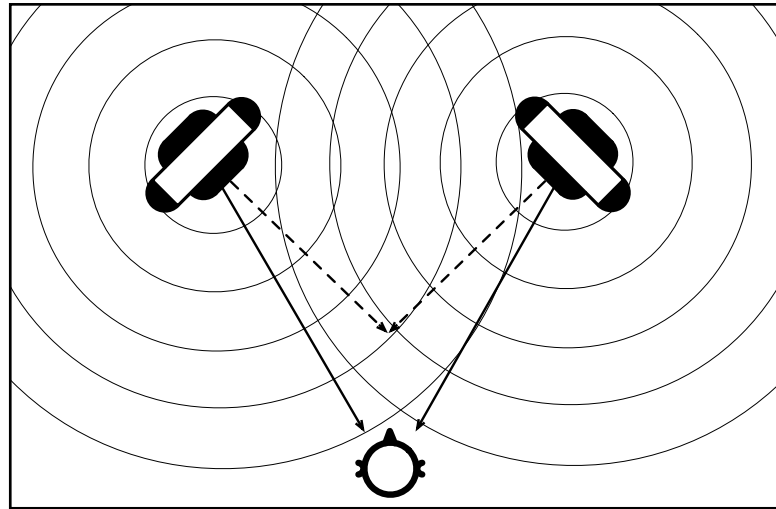

LS1 setup with 30° angle

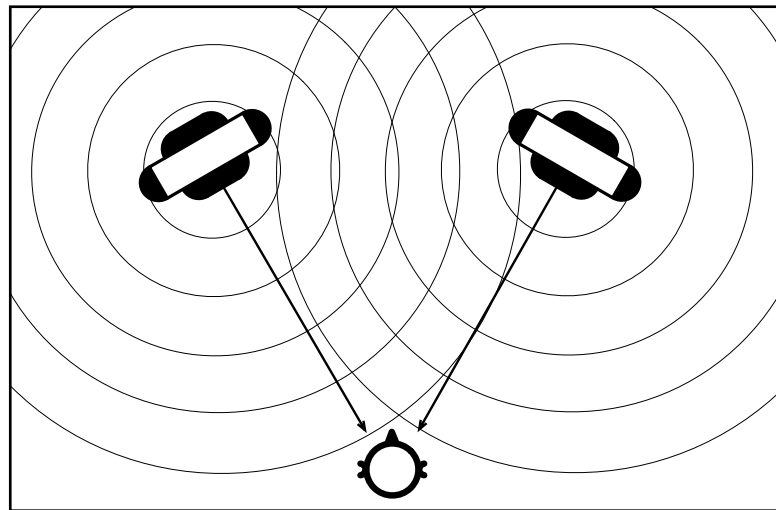

Toe-in angle - Because of the acoustic properties of its wide baffle, the off-axis sound level of the LS1 becomes gradually softer for all frequencies above 250 Hz when the angle is larger. Since its tweeter has a wide dispersion up to high frequencies, the LS1 approaches this theoretical response very well. Grimm Audio LS1's can therefore be used successfully in a 'toe-in' setup. The preferred toe-in angle for the LS1 is 45°, so the right-angle projection of the tweeters meet 0,5m-1m in front of the listening position (see the 'LS1 setup with 45° angle' picture). When using this toe-in angle in the right acoustics, the LS1's offer an even wider sweetspot and an enhanced spaciousness. To make sure the direct sound frequency response (that is 15° off-axis in this case) is still flat, you should select the '45°' option in this preference setting. This engages an EQ that compensates for the slight treble roll off at 15°. In some acoustic environments, aiming the speakers directly at the listeners position (as in the 'LS1 setup with 30° angle' picture) works better. If in your room you prefer this classic 30° positioning, please select the corresponding preference option to keep the on-axis response optimally flat. Some people prefer a 'toe-out' setup, with the speakers pointing 15° outwards. This offers a less focussed phantom centre and a more diffuse, 'larger', sound. In that case, again use the '45°' setting for compensating the treble roll off at the listening position. In case you like to place the LS1's parallel to the wall ('0°') it is also advised to use the '45°' setting and maybe apply some EQ to taste (see next page of the preferences).

Power LED brightness - This can adjust the brightness of the white LED in the LS1 cabinets.

Sensitivity - This reads the analog input reference level from the indicated speaker, that is set with the tiny sensitivity control at the back of each LS1. Please select the speaker to read (the system reads one speaker at a time). When using analog sources like a phono pre amp, you can use the sensitivity control to set the optimal level. The goal is to adjust the sensitivity until the loudness is at nominal level with the LS1 volume set to the 0 dB reference level. Make sure all speakers in your system are set to equal analog sensitivity.

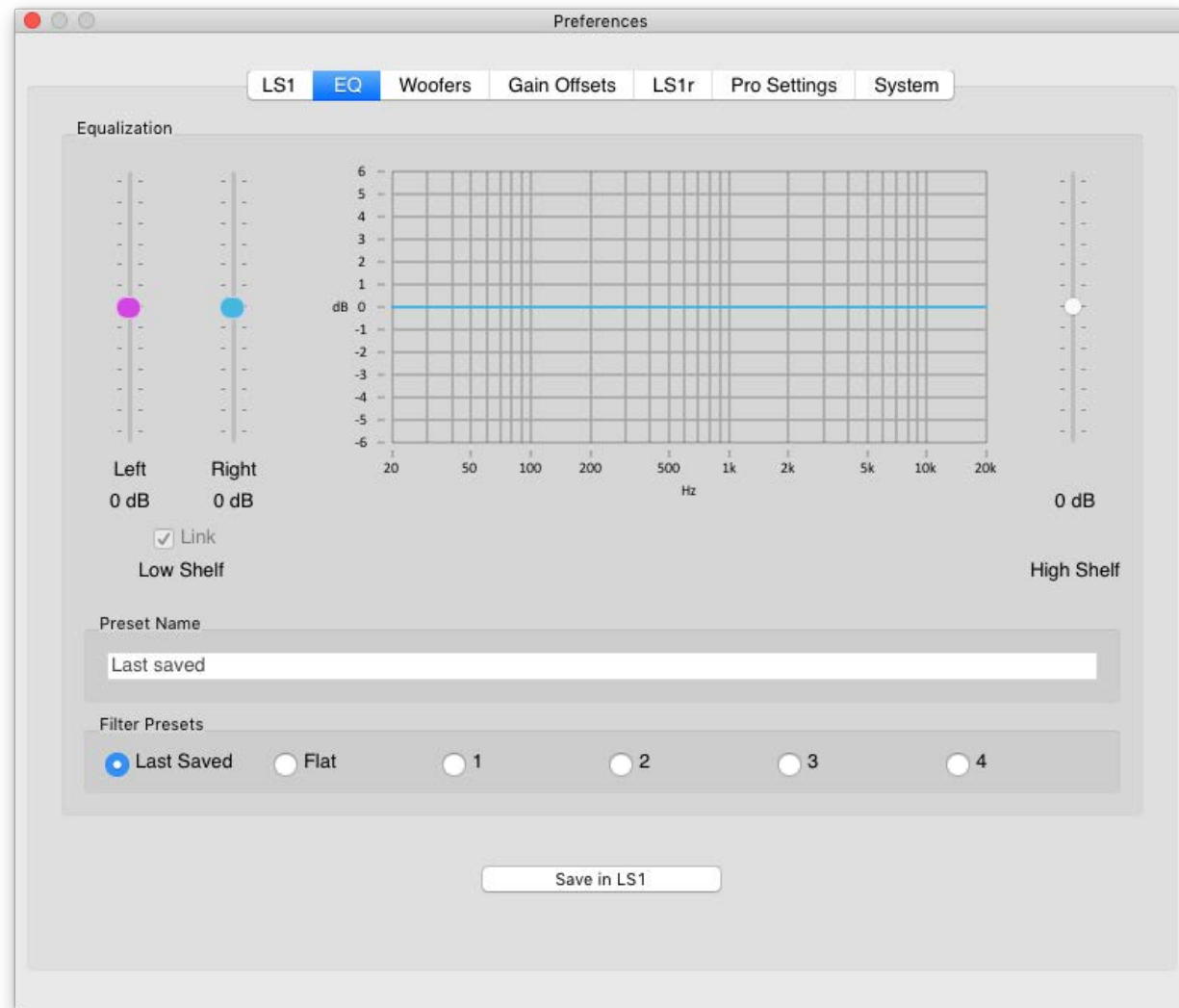

The next page shows the **EQ** settings. The LS1 EQ can be used to apply some gentle acoustic correction in the bass and adjust the treble to taste. There's an option to save up to 4 preferences, that can be used for different listening conditions. One setting can be saved in the LS1 as the standard EQ curve which is used at power up.

Filter Presets - If the 'Flat' preset is selected, the faders of the EQ cannot be operated. The 'EQ' button in the main window of the LS1 remote software will be turned 'off'. By clicking the 'Last Saved' preset, the display shows the current setting of the LS1 internal memory. Again, the faders can not be used. If you select one of the four remaining presets, the EQ faders become functional and can be set to taste. By clicking the 'Save in LS1' button you save an EQ setting to the LS1 internal memory. This EQ will be used when the remote software is not running.

Preset Name - Here you can change the name of the selected preset. By default the preset names are 1, 2, 3 and 4.

Low Shelf - The faders on the left of the graph control a low shelf EQ. This filter influences the energy below the so called 'baffle step' of the LS1, which is the frequency below which the LS1 starts to radiate energy omnidirectionally (approximately 250 Hz). If the LS1's are placed close to a wall, you may like to attenuate the bass a bit since the energy radiating to the back is now reflected in phase always and adds up to the direct sound.

There are two controls to set the left and right channels independently. By ticking the 'Link' option, both faders move in unison, with a possible offset. Double clicking on a fader sets it to 0 dB. The purpose of setting a different low shelf filter for left and right is to compensate for a possible difference in the acoustic environment of the left and right speaker. Imagine the left speaker being placed in a corner and the right speaker just against a wall. Every boundary gives an increased response in the low end due to reflections. The left speaker will therefore receive more reflected energy from nearby surfaces than the right speaker. If you compare the bass of the two speakers you will notice it is louder on the left. In this case, adjust the two low shelf filters until the low end on both speakers sounds as even as possible. Mark that moving the speakers around a bit can have a dramatic influence on the low end response and it is certainly worthwhile to spend some time optimizing the speaker positions before using the low shelf EQ.

High Shelf - The high shelf fader controls the treble EQ for left and right speaker simultaneously. If the fader is set to 0 dB, the frequency response at the listening position is linear up till very high frequencies (when the 'Toe-in angle' setting of the LS1 page is set correctly). In case you like to adjust the treble response to your own taste, please use this high shelf EQ.

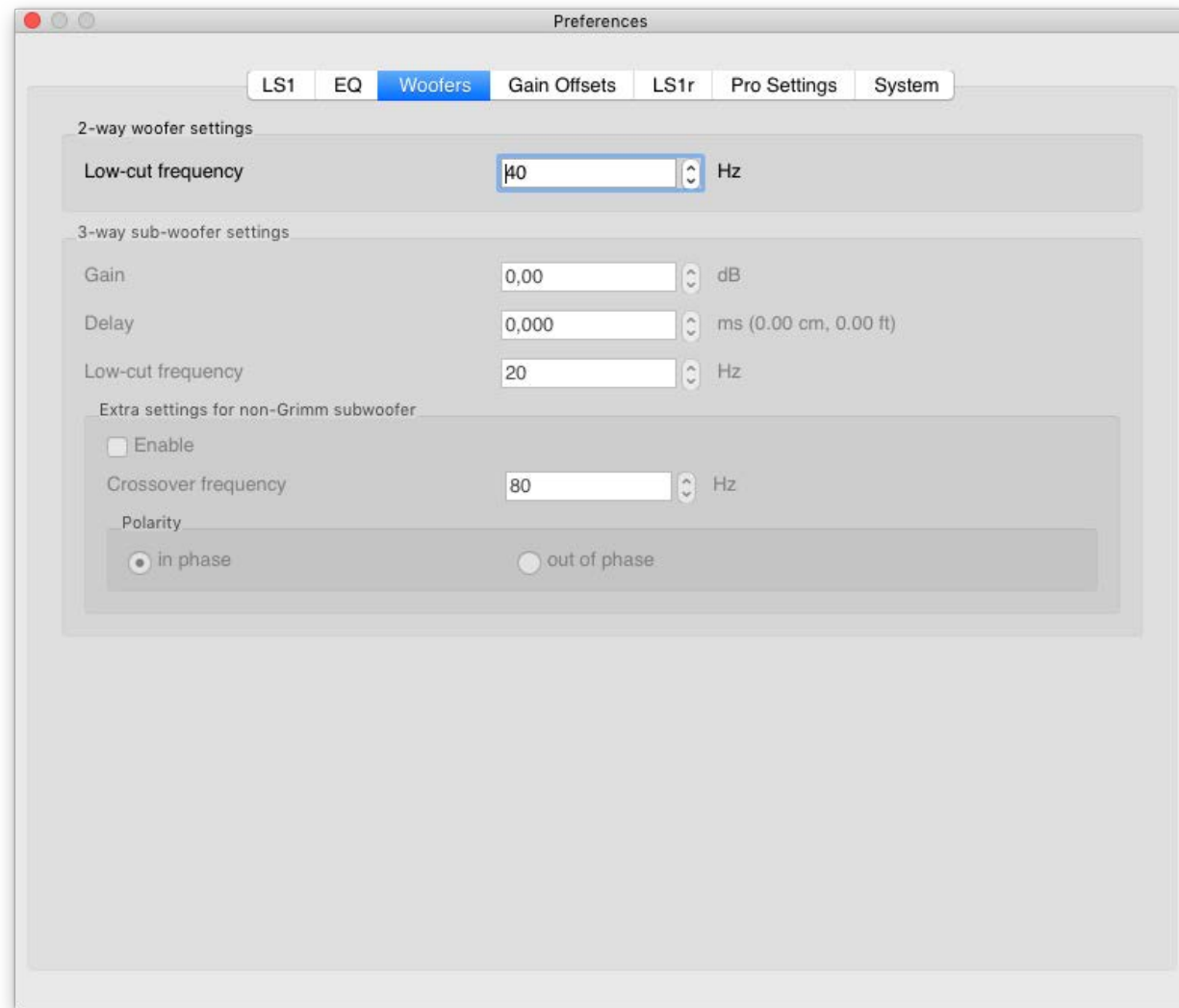

One tab to the right you will find the **Woofers** page. Dependent on the selection of a 2-way or 3-way loudspeaker on the 'LS1' page, you will find either the 2-way settings or the 3-way settings active.

2-way woofer settings - The only parameter here is 'Low-cut frequency'. The LS1 can be completely linear down to 25Hz, even as a two-way system without the subwoofers. Choosing a low cutoff frequency will however limit the maximum playback level. In practice 35Hz to 40Hz is a good compromise between a low enough bass and a loud enough playback level.

3-way woofer settings - Here you can control some parameters of a connected subwoofer. First you can set the *gain*. If you use the Grimm LS1s subs, the system is linear in the free field (on-axis) with a 0 dB setting. Dependent on your acoustics you may like to use a slightly lower or higher value. Since the crossover frequency is 70 Hz, the gain control acts like a low-shelf EQ below this frequency. In case you have installed a double amount of in total four subwoofers along the walls of your room to cancel room modes and improve the bass response, you will need to select a value around -6 dB. When using a 3rd party subwoofer, please set the gain for the audibly or measurably most linear level. The preferred method is to first set the software gain to 0 dB and align the subs own gain control (if available) until switching between 2-way and 3-way shows just a marginal difference in sound color. You may then fine tune the subwoofer level with the software gain.

The next parameter is *delay*. Use this to compensate for an offset between the acoustic origin of the subwoofer and the main system. This can be caused by room acoustics (for instance by large obstacles like a mixing console), or when you have placed the subwoofers against a wall instead of on the LS1 footplate. The display shows the compensation delay in ms, cm and feet. To find the optimum setting, switch between '2-way' and '3-way' and experiment with the delay setting until the '3-way' selection offers at least the same amount of 'punch' as the '2-way' setting.

The third parameter is *low cut*. This controls the deepest corner frequency of the subwoofer and therefore of the whole system. Normally it is set at 20 Hz, but it may be helpful to set it higher in case there's a room mode resonance to tame. A higher frequency also yields a slight increase in possible playback level.

If you like to connect a non-Grimm Audio subwoofer to your system there are two extra settings. To activate them you need to tick the 'enable' button.

-> *Never use the non-Grimm subwoofer option with a Grimm Audio LS1s subwoofer. The frequency response of the LS1s is linearized in the LS1 DSP and the woofer / sub-woofer crossover is phase compensated. Both functions are de-activated in the non-Grimm subwoofer mode.*

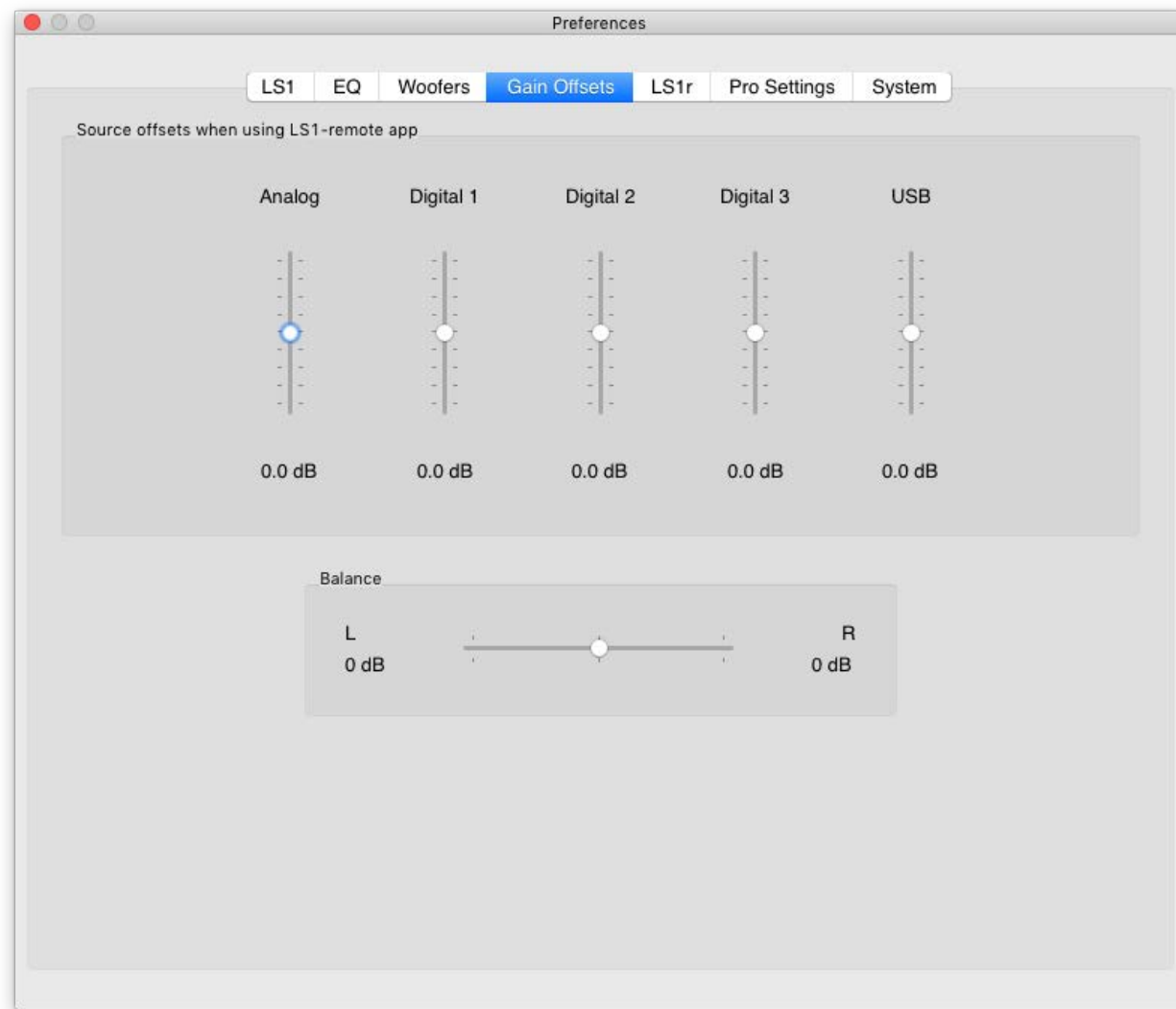

With the *Crossover frequency* function you can set the crossover frequency for the 3rd party subwoofer. If possible, please make sure to set your subwoofer to 'linear' and use the crossover of the LS1 in stead of the filter in the sub. A crossover setting near 70 Hz will usually work well. The final parameter is *polarity*. You may turn the polarity of the subwoofer in phase or out of phase to optimize the crossover region.

The next page offers the **Gain Offsets**. All input channels (analog, digital 1, digital 2, digital 3, USB) can get a gain offset to align their level with the other channels. This is convenient in general but is essential when comparing the sound quality of two sources ('A-B testing'). To reset a fader to 0 dB, just double click the fader knob. Mark that the offset is only active when the PC remote software is running.

Below the gain offset window there's a *Balance* slider to correct for off-center listening or an acoustical imbalance between left and right. In most cases it is kept at the center position. If you accidentally moved it, just double click the fader knob to reset it to 0 dB.

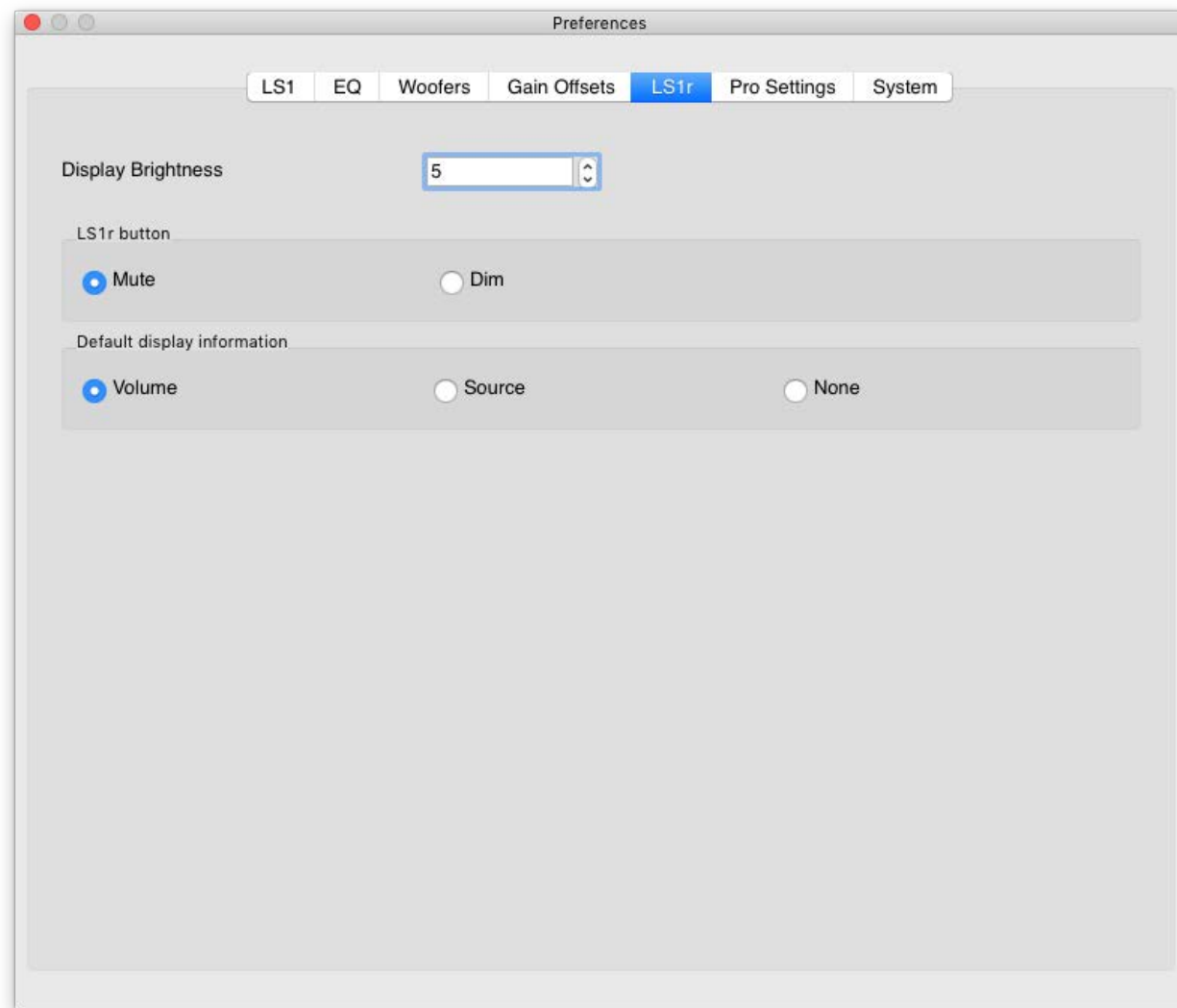

Next up are the **LS1r** Controller settings. Here you can control the brightness of the LS1r Controller display. Additionally you can choose whether pressing the big volume dial activates the MUTE or the DIM function and if the display shows the volume, the input source or nothing at all.

One tab to the right you will find the **Pro Settings** page. These are in general only useful for professional audio engineers.

The first option is the *Midi connection settings*. If a Grimm Audio USB interface is connected to your computer, it is usually automatically selected by the LS1 remote software. Otherwise you can select it from the drop down menu. If you use a DAW controller with a control room fader that transmits midi volume data, it can replace the LS1r Controller. In that case select the DAW controller (or an associated virtual midi channel) for input data and the LS1 USB interface for output data. If you do not own the LS1 USB interface, you can also use a generic midi interface to communicate with the LS1. Grimm Audio can supply a 'midi to Grimm cat5' conversion box to you.

Display zero reference - In this section the reference levels 1 and 2 can either be set or restored to default. The default '0' level is equal to the international reference used in mastering. Technically speaking, at the reference level a reference noise of -20 dBFSrms will give you an acoustical level at the listening seat of 79 dBC. This was called 'K14' by mastering engineer Bob Katz and is the level where nineties pop music was mastered at. In more recent days pop music masters have become considerably louder and you probably have to adjust your volume control to lower levels for a comfortable monitoring level. In any case it is very good practice to work at standard playback levels or at least regularly check you mix or master at reference level.

Since results are dependent on room acoustics, you probably have to adjust the 0 dB position of your volume control to the correct level. Please measure the acoustic level of the reference noise in your room at the listening position with a professional sound level meter. Adjust the volume control for 79 dBC. You may now program this as your 'reference' 0 dB level in the software by clicking the 'Current level to Ref 1' button. The display on the left indicates the offset you have relative to the factory default level. If you now like to quickly set the volume control to the stored 0 dB reference, just double click the Ref 1 button in the main window. To use a second reference level at a lower or higher gain position, you can store it as 'Ref 2' by setting the volume to your preferred second reference level and then clicking 'Current level to Ref 2'. You can always click 'restore default' to go back to the factory levels.

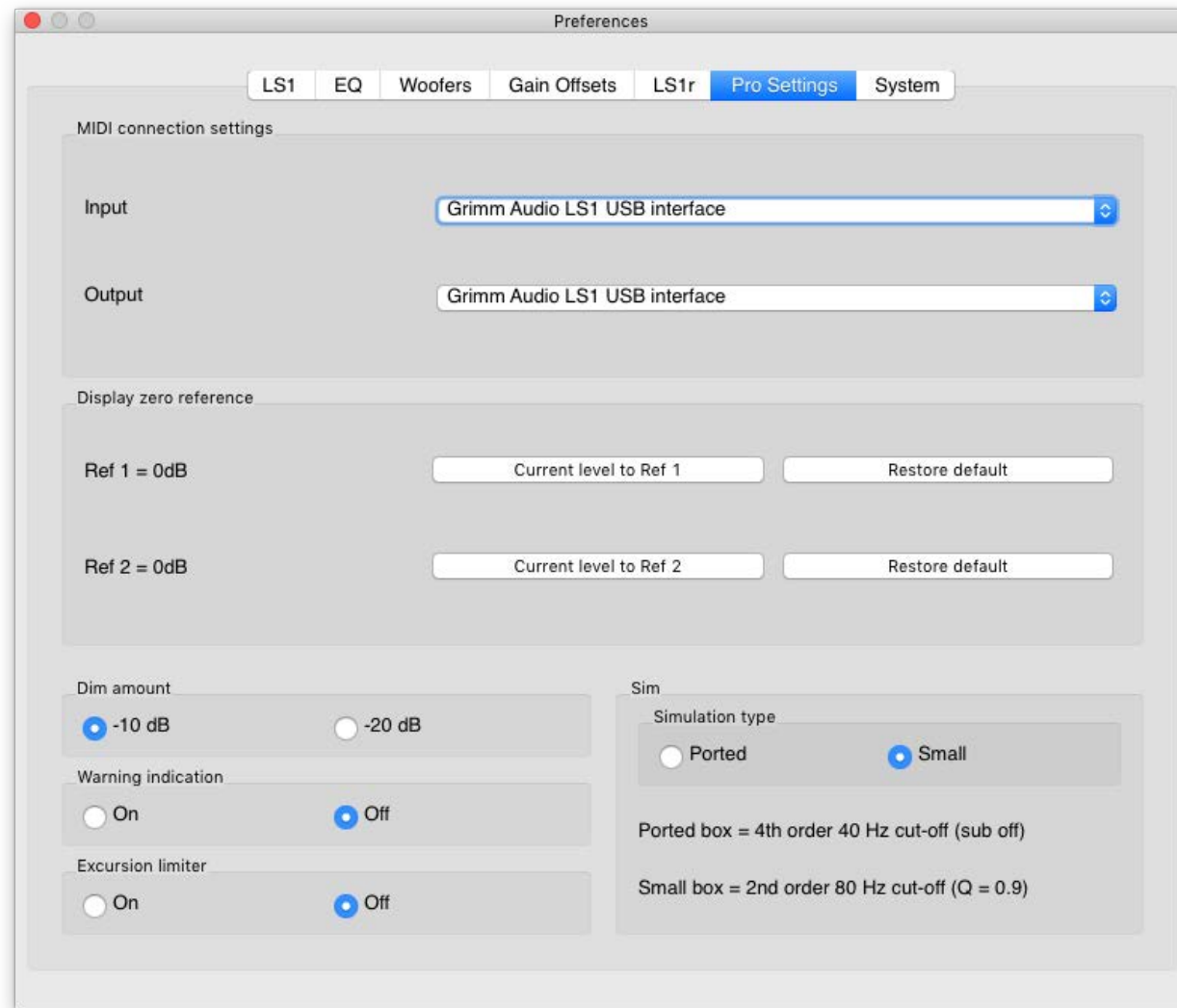

Dim amount - Here you can choose between a dim (temporarily attenuation) value of either -10dB or -20dB. The Dim function is activated in the LS1 remote software main window or (optionally) by pressing the volume knob of the remote.

Warning indication - This turns on a warning indication by blinking the power LEDs on the LS1 fronts. The indication is triggered when the excursion limiter or other safety systems like clip or heat limiters set in and the LS1 system is not perfectly linear anymore. If the warning indication is off, the actual limiters will still be active, but you will not be notified. It is very normal for loud-speakers and amplifiers to occasionally operate outside their linear range, so in normal use the warning indication can be distracting and we advise to turn it off. However, when mastering an album it can be informative to know that your monitor system is not completely linear at a certain moment. In that case, turn the indication on.

Excursion limiter - You can use this limiter to protect your speakers from damage when using them as a monitor during tracking or foldback monitoring of musicians that perform in the control room. Instead of putting a simple limiter on the audio signal, we control the maximum possible excursion of the driver. As long as the excursion limiter does not come into action (which will be indicated by the blinking led) there is no audible effect of this protection circuit. For hifi or mastering we advise to turn off the excursion limiter. Signals of mastered music are rarely powerful enough to harm loudspeakers.

Sim - Here you can choose the character of the Sim button in the main window. Either select the simulated sound of a ported bass-reflex or of a small bookshelf type speaker with a low-cut of 80Hz.

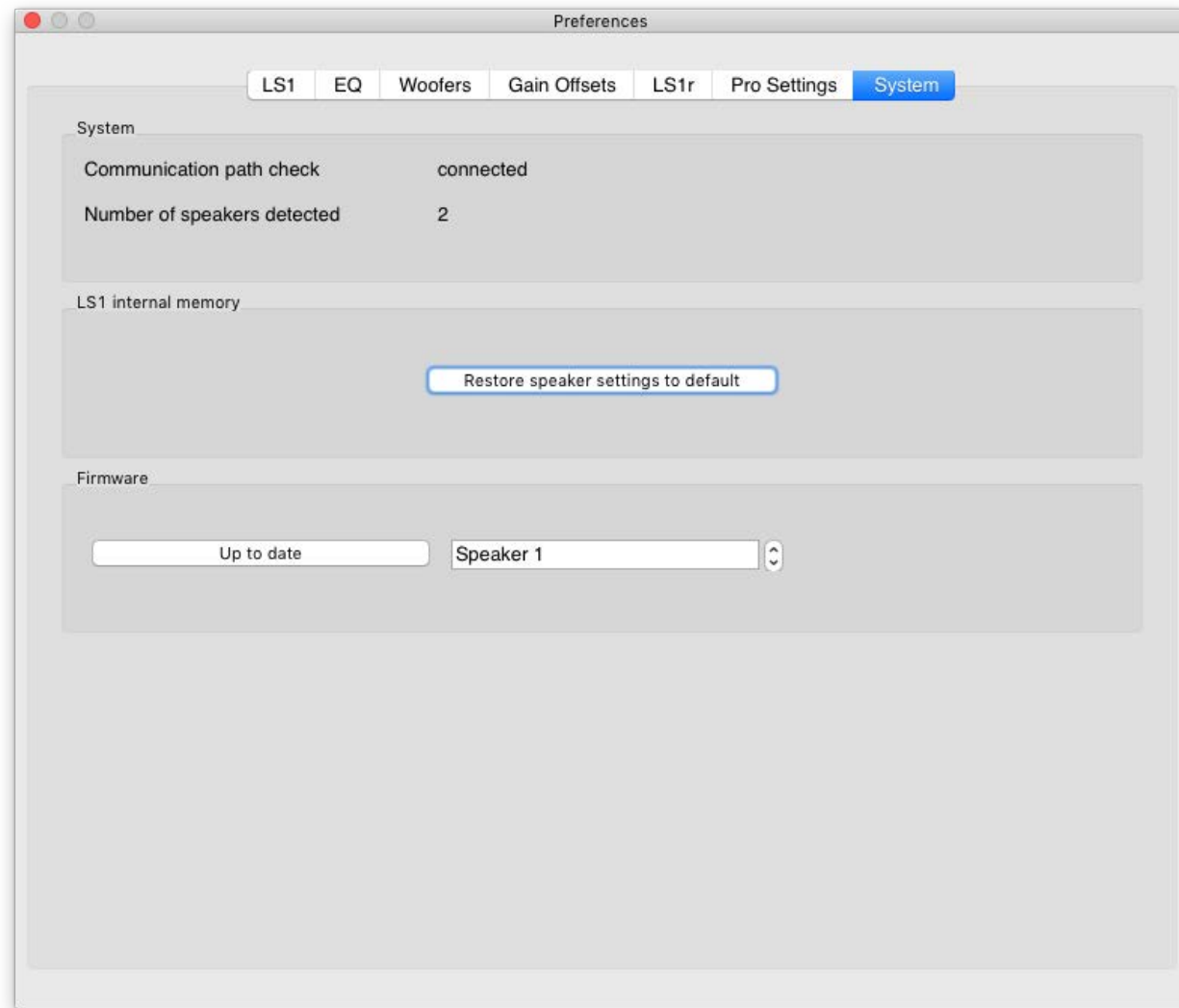

The last tab: **System.**

System - Here you can see if the communication path between all parts of the chain (LS1r Controller, software remote, and LS1's) is properly working. In case you find an error message, please check the wiring and whether you have inserted the little cat5 'loop back' plug in the last LS1's 'Thru' connector.

If everything is running fine, there's an indication of the amount of LS1's detected in the chain.

LS1 internal memory - By clicking the button 'Restore speaker settings to default' you bring all settings of the LS1 back to the factory default state.

Firmware - In this field the firmware version of the connected LS1's is indicated and you can compare it to the firmware version that is shipped with the LS1 remote software. If you see the software has a newer firmware version than your LS1's, you are advised to perform a firmware update. Please first select a speaker in the right-hand menu and then press the 'Do firmware update' button. This will start the update procedure for the selected speaker. The process takes some time, please allow it to finish completely before touching anything. Once the upload is finished the speaker will reboot and when it's up again, the software shows that the firmware is up to date.

Warning! Before starting a firmware update, please take care of the following precautions:

1. Stop all music playing.
2. Do not touch the LS1r Controller during the firmware update process.
3. You can select one speaker at a time in the interface. Please let the updater finish before selecting another speaker.

To be completely safe when using the firmware update function, connect just one LS1 at a time to the USB interface and remove the LS1r Controller. Please make sure the 'loopback connector' is in place on the connected speaker, or the update process will not start.

-> if you have any questions about updating the firmware, please make sure to contact your dealer first.

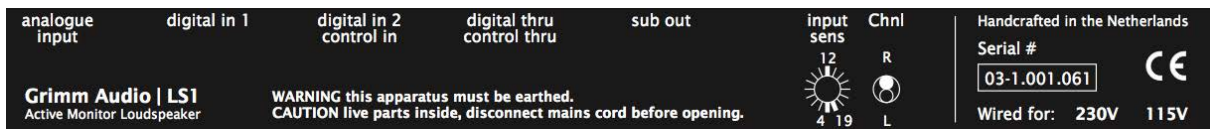
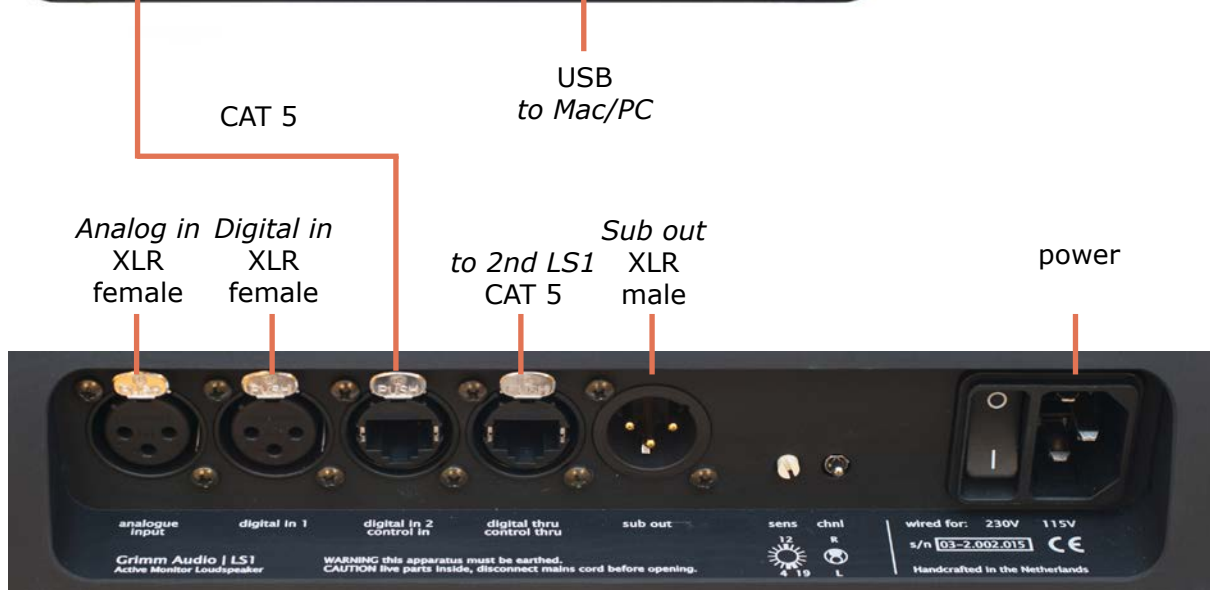

In this chapter we will inform you about how to connect all cables to setup the whole playback system. Please follow these cabling instructions carefully.

1. Being an active system, the LS1 needs power, so the active leg of each speaker has an IEC power connector that needs to be connected to a power outlet. If you have the three-way system with the additional LS1s subwoofer, you will only need to connect the subwoofer to the power outlet. More information about connecting the three way system with subwoofer can be found at the end of this Connectivity chapter.

Warning! For your own safety, please use outlets with safety earth.

2. Now you can connect the LS1i USB interface to the speakers. In our example we will start with the left speaker, so we connect the **'To LS1 control in'** with the **'digital in 2 / control in'** of the left speaker via the CAT5 cable. In case this simplifies your wiring, feel free to connect to the right LS1 first. In the Software Control Settings you can select which speaker is first in the chain.

3. The supplied USB cable is connected from the usb-interface to a free USB port of the pc that has the LS1 remote software installed.

4. Connect the LS1r Controller to the usb-interface. One of the supplied CAT5 cables goes from the **'remote out'** on the LS1r Controller to the **'remote control'** input on the usb-interface.

5. Now connect the left and right LS1 with the second CAT5 cable, going from the **'digital thru / control thru'** output of the left speaker to the **'digital in 2 / control in'** of the right speaker.

6. Last but not least, plug the little CAT5 **'Loop Back Connector'** (that you can find in the accessory box) into the **'digital thru / control thru'** socket of the right speaker. It 'closes the loop' for the control data so the DSP's in the LS1's can communicate with the LS1r Controller and the LS1i USB interface.

Please do not use a generic CAT5 loopback connector! If you misplaced your LS1 loopback connector, please contact Grimm Audio for a replacement unit.

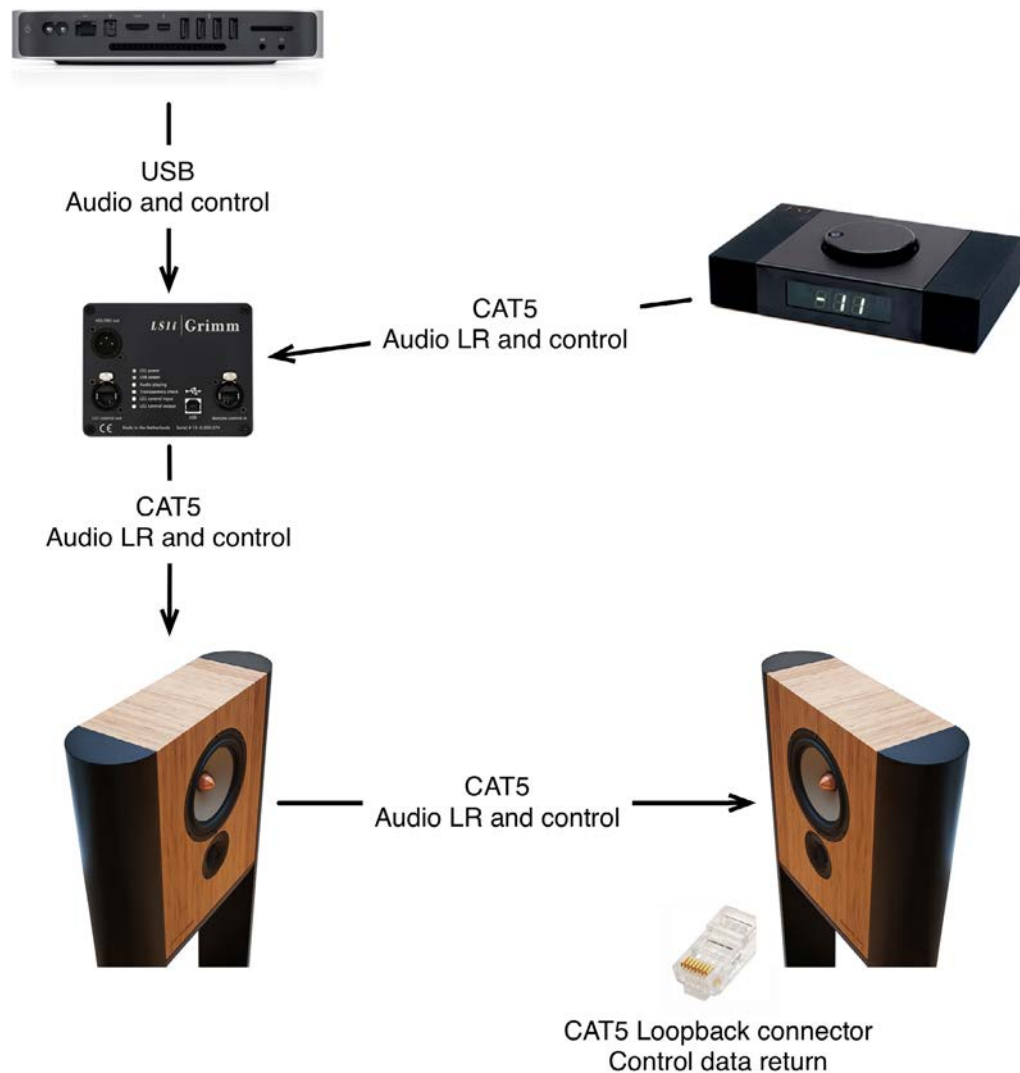

7. If you use a subwoofer, each LS1 has a **'sub out'**, that offers an already filtered analog line level signal. The filter settings can be chosen in the LS1 Remote software preferences. In case you own the Grimm LS1s subwoofers, please also read the following paragraph about connecting the LS1s subs.

8. The **'AES/EBU out'** XLR-out on the usb-interface will not be used in a hifi-setup.

(-> In a studio situation this output provides the digital AES/EBU from the USB source that can be looped through to a digital audio meter)

Your wiring should now look a bit like on the left page and your basic system setup is finished. All that is missing now is some music! So let's have a look at the different source options.

The LS1 has three types of connectors:

XLR male/female: Used for symmetrical signal transmission via two wire shielded cable. This can be either an analog or a digital connection. Digital cables carry two channels (left and right) in one cable.

CAT5: Used for data transmission of AES/EBU digital audio and control data via an ethernet style cable. The loopback-connector that is inserted at the 'end of the chain' enables bi-directional data transmission between the computer, the LS1r Controller and the internal dsp's in the LS1.

*Please mark that the LS1 only uses the physical CAT5 connector that is also used for ethernet, but it is **not** a network connection. NEVER connect the LS1 to an ethernet router or computer!*

USB: Used for connecting a computer or media player.

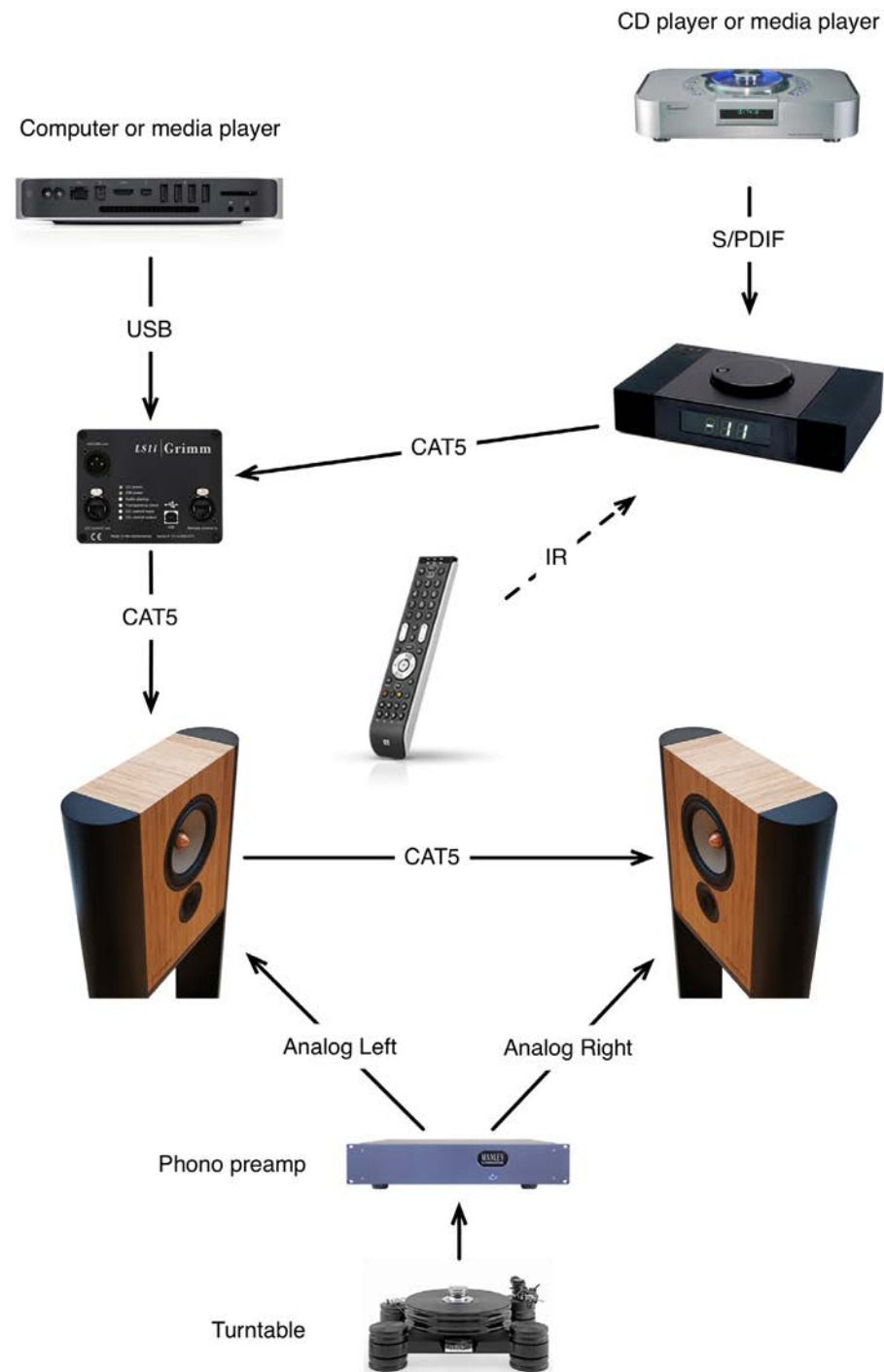

The LS1 offers the following music source options:

1. Analog input on the left and right LS1

-> Here both speakers must be connected to the respective left or right line level output from your analog source. If no LS1r or LS1i is connected and there is no digital source present, the LS1 defaults to the analog input.

2. Digital input on the main LS1

-> In case your source has a digital S/PDIF (RCA-connector) out instead of an AES/EBU (XLR-connector) out, please use the supplied adapter cable, which takes care of the impedance matching inbetween those!

3. Digital inputs on the LS1r Controller

The LS1r Controller has two additional digital inputs. This keeps cable connections short and tidy, as the remote can be put right next to the source.

4. USB input on the LS1i USB Interface

The LS1i can be connected to a mac, windows or linux PC. It can also be used as a 'USB DAC' for media players that have a USB output. The LS1i USB interface can handle PCM audio up till 384 kHz ("DXD"), plus DSD64 and DSD128.

-> The computer will recognize the Grimm Audio usb interface as a usb soundcard device. It has to be selected in the audio settings of your operating system. This enables you to stream audio files directly from your mac, windows or linux pc to the LS1.

CD player or media player



S/PDIF



IR



CAT5

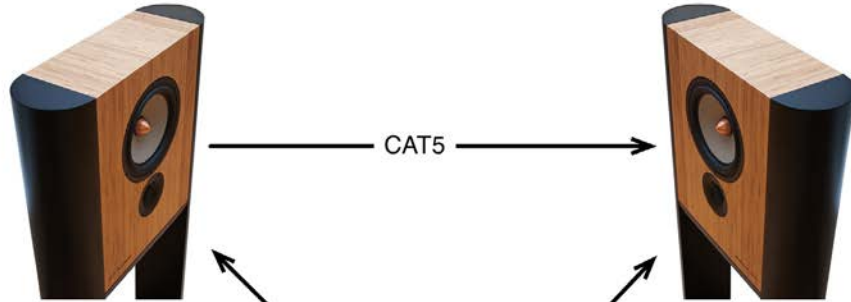

Analog Left

Analog Right

Phono preamp



Turntable



In case you do not use a pc or media player with 'USB DAC output' for music playback, you may remove the LS1i USB interface from your system after the initial setup. The connections are as pictured on the left page. As you can see, the LS1r Controller is now directly connected to the first LS1. Whenever you feel need to make adjustments to the LS1 preference settings, just connect the LS1i USB interface again. The input options in this case are as follows:

1. Analog input on the left and right LS1

-> Here both speakers must be connected to the respective left or right line level output from your analog source. If no LS1r or LS1i is connected and there is no digital source present, the LS1 defaults to the analog input.

2. Digital input on the main LS1

-> In case your source has a digital S/PDIF (RCA-connector) out instead of an AES/EBU (XLR-connector) out, please use the supplied adapter cable, which takes care of the impedance matching inbetween those!

3. Digital inputs on the LS1r Controller

The LS1r Controller has two additional digital inputs. This keeps cable connections short and tidy, as the remote can be put right next to the source.



Connecting the Grimm Audio LS1s subwoofers for a three-way LS1 system:

If you have decided for the three-way-version of the LS1, there are only two additional connections to be made per speaker.

The supplied symmetrical audio cable (XLR female -> male) connects the filtered and corrected audio signal from the 'sub out' connector of the LS1 to the 'input' connector of the subwoofer.

Unlike with the two-way system the power cable is now plugged into the subwoofer.

Please use the short male to female power cable that we supply with the LS1s to connect power from the LS1s power outlet to the LS1. The power switch on the LS1 electronics can now always be left on and the complete system is powered on/off via the power switches on the subs.

You can see how this is done in picture on the left. This again keeps the living room tidy and avoids unnecessary clutter from cables.

Table Of Contents

Notes

1.	Welcome / Overview	page 5
2.	The Acoustics / The Electronics	page 6
3.	Positioning	page 8
4.	LS1s - Subwoofer	page 12
1.	Unpacking And Assembly	page 14
5.	Hardware Control Settings	page 24
6.	LS1r - Controller	page 26
7.	Software Control Settings	page 32
8.	Connectivity	page 56
10.	Table Of Contents / Notes	page 66
11.	Technical Specifications	page 68
12.	Warranty Information	page 69



Frequency response:

20 Hz - 27 kHz +0.5dB/-3dB
30 Hz - 20 kHz +/- 0.5dB (unsmoothed!)
Deviation from linear phase: <10 Degrees

Amplifier power:

2 x 120 Watt (per side); 400 Watt (per Sub)
Idle power, drawn from mains: 16W per LS1

Max SPL:

(about) 105dB

Signal to noise ratio:

114dB (unweighted)

Crossover functions:

1550 Hz - 4th order Linkwitz Riley
70 Hz - 2nd order Linkwitz Riley (3-way system)
sum corrected to linear phase in normal mode,
not corrected in 'low-latency' mode.

Supported sample rates:

44.1 - 192 kHz
Via USB with LS1i USB interface: 44.1 - 384 kHz ('DXD'), DSD64 and DSD128

Level:

The default '0' setting of the LS1 remotes volume setting gives 79 dBC at the listening position with a -20 dBFS reference noise ('K14').

Latency:

7.3 ms (2-way)
40 ms (3-way)
5 ms in 'low-latency' mode

Current drawn from USB: 250mA.

Maximum allowed USB cable length: 2m

Height: either 1150mm for Hifi use (standard sofa height) or 1450mm for studio use.

Width, Depth: 520mm x 160mm

Cabinet volume: 14 liters

Grimm Audio Limited Warranty

Grimm Audio CV ('Grimm Audio') warrants this product to be free of defects in material and workmanship for a period of five (5) years for parts and for a period of five (5) years for labor from the date of original purchase. This warranty is enforceable only by the original retail purchaser and cannot be transferred or assigned.

During the warranty period Grimm Audio shall, at its sole and absolute option, either repair or replace free of charge any product that proves to be defective on inspection by Grimm Audio or its authorized service representative. In all cases disputes concerning this warranty shall be resolved as prescribed by law. To obtain warranty service, the purchaser must first call or write Grimm Audio at the address and telephone number printed below to obtain instructions where to send the unit for service. All enquiries must be accompanied by a description of the problem. All authorized returns must be sent to Grimm Audio or an authorized Grimm Audio repair facility postage prepaid, insured and properly packaged. Proof of purchase must be presented in the form of a bill of sale or some other positive proof that the product is within the warranty period. Grimm Audio reserves the right to update any unit returned for repair. Grimm Audio reserves the right to change or improve design of the product at any time without prior notice.

This warranty does not cover claims for damage due to abuse, neglect, alteration or attempted repair by unauthorized personnel, and is limited to failures arising during normal use that are due to defects in material or workmanship in the product.

In no event will Grimm Audio be liable for incidental, consequential, indirect or other damages resulting from the breach of any express or implied warranty, including, among other things, damage to property, damage based on inconvenience or on loss of use of the product, and, to the extent permitted by law, damages for personal injury.

© 2015, Grimm Audio CV.

All rights reserved. Reproduction in whole or in part is prohibited.
Specifications subject to change without notice.

Grimm Audio contact information:

Grimm Audio CV
Strijpsestraat 94
5616 GS Eindhoven
The Netherlands
+31 (0)40-213 1562
Email: info@grimmaudio.com
Website: <http://www.grimmaudio.com>

Grimm Audio
Strijpsestraat 94
5616 GS Eindhoven
The Netherlands

info@grimmaudio.com
www.grimmaudio.com