

Ayre QX-5

# Owner's Manual

---



Digital Hub

---

## Table of

# Contents

---

<i>Welcome to</i>	Ayre . . . . .	2
<i>Connections and</i>	Installation . . . . .	5
<i>Setup and</i>	Configuration . . . . .	10
<i>Controls and</i>	Operation . . . . .	26
<i>Optimization and</i>	Customization . . . . .	34
<i>Numbers and</i>	Specifications . . . . .	42
<i>In Case of</i>	Trouble . . . . .	43
<i>Statement of</i>	Warranty . . . . .	49
<i>A Place for</i>	Notes . . . . .	53

Welcome to

# Ayre

---

*To our North American customers, please be sure to mail your warranty registration card and photocopy of your original sales receipt within 30 days in order to extend the warranty from 90 days to five years.*

Your Ayre QX-5 Twenty offers a significant advance in the musical performance of high-fidelity equipment. The warmth and immediacy of a live performance are apparent from the first listening. The combination of superb resolution and a natural, relaxed quality will draw you into the music time and time again.

This level of performance has been implemented using the highest level of workmanship and materials. You can be assured the QX-5 Twenty will provide you a lifetime of musical enjoyment.

## Quick Start

---

*The information required to get started is contained in the following three chapters of this manual. The remaining chapters cover additional information that may be read at your leisure.*

The Ayre QX-5 Twenty is a digital hub, a device which allows you to integrate all of your digital sources into one point of control. It is extremely flexible and versatile, improving the performance of all your digital sources. In order to immediately begin enjoying music from the QX-5 Twenty, you first need to connect any digital sources to the rear panel of your unit.

Out of the box, all inputs of the QX-5 Twenty will be active, but both the Ethernet and USB inputs will require some configuration. Please see the section of the manual called Ethernet Input and USB Input, respectively (pg. 17). For all other inputs, simply sending them a signal from your other devices will commence playback.



For streamlined use of the QX-5 Twenty, disabling unused inputs allows for simplified operation, see (pg. 36).

*One of the first things to do after unboxing and powering on the QX-5 is to decide how you'll use it in your system.*

The QX-5 Twenty can be listened to in three different ways. Shipped from the factory, it is set in preamplifier mode. For instructions on how to change to DAC mode or Headphone mode, see Modes of Operation (pg. 34).



**The default volume level in preamplifier mode is 60. Use the control ring on the faceplate or volume buttons on the remote handset to adjust the volume.**

## Controls and Display

---

During normal operation the display of your QX-5 Twenty will show the selected input in the left-hand side of the window. In the right-hand side of the window, information about the format being played back and the sample rate will be displayed. If preamplifier mode is being used, whenever the volume level is changed, the right-hand side of the display will briefly show the volume level.

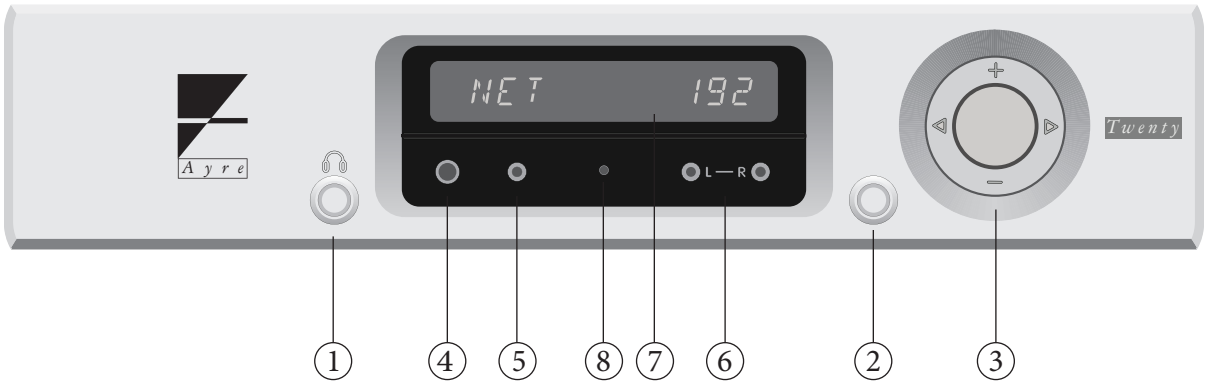

1) Left-hand button

- Headphone functionality
- Menu navigation

2) Right-hand button

- Mute
- System-sleep mode
- Menu navigation

3) Control Ring

- Input selection (◀▶)
- Volume up/down (+ -)
- Menu scrolling (◀▶ + -)

4) 1/4" single-ended headphone connector

5) 3.5mm single-ended headphone connector

6) 3.5mm balanced headphone connectors (L — R)

7) Display

8) IR receiver

# Installation

---

The Ayre QX-5 Twenty is easy to set up and use. The following guidelines will ensure that the installation goes smoothly.

A good location for the QX-5 Twenty is in an open-backed cabinet or on a shelf. In order not to block the airflow to other components, the unit should not be stacked directly on top of another product.

*The infrared beam of the remote handset will also travel through glass.*

The receiver for the remote control is positioned between the headphone jacks on the front panel. A direct line of sight from the listening position will ensure maximum range.

## Inputs

---

The Ayre QX-5 Twenty offers ten digital inputs. In this era of diverse source components, it is not practical to pre-label the inputs with the name of the source.

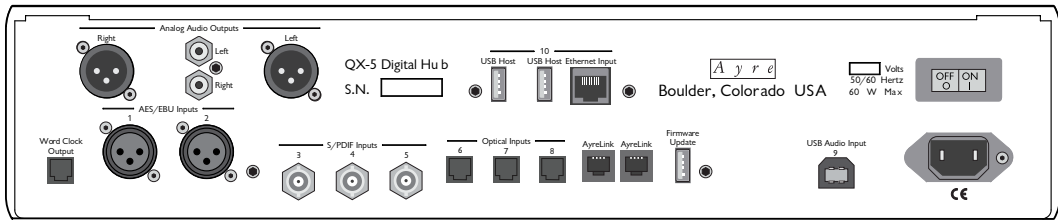

The inputs are labeled “1” through “10”. If you so choose, you may name each of the numbered inputs to either one from a pre-selected list or create a custom name, see (pg. 37). The inputs are as follows:



Two (2) AES/EBU inputs with XLR connectors, (labeled “1-2”)



Three (3) S/PDIF inputs with BNC connectors, (labeled “3-5”)



Three (3) optical inputs with Toslink connectors, (labeled “6-8”)



One (1) USB input with a USB “A” connector, (labeled “9”)



One (1) Ethernet input which includes one RJ45 connector and two associated USB host connectors, (all labeled with the number “10”)



Make a written note of which source components are connected to which numbered inputs, if you plan to create custom names for each input in the menu.

## Outputs

---

The QX-5 Twenty has both line-level outputs on the rear panel and headphone outputs on the front panel.

### Main Outputs

---

The QX-5 Twenty connects to your preamplifier, integrated amplifier, or power amplifier via the main outputs. The pair of XLR outputs provide a high quality connection to your system. A pair of RCA outputs are also provided for legacy equipment.

### Headphone Outputs

---

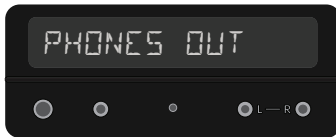

Headphones can be connected easily to the front of the QX-5 Twenty. Directly below the display you'll find four connectors; two for single-ended headphones and two for a set of balanced headphones.



The two connectors on the left (one in 1/4 inch diameter and the other in a 3.5 mm diameter) will allow you to listen to headphones in single-ended mode.



The two connectors (2 x 3.5 mm connectors) on the right will allow you to listen in an optimized configuration known as balanced mode or



*With balanced operation, each channel has two equal and opposite signals, compared to just one signal per channel with conventional circuits.*

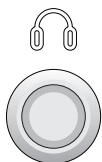

symmetric mode. We recommend balanced mode for your listening purposes, as it will improve the level of performance provided to you by the headphone amplifier in the QX-5 Twenty.

Pressing the left-hand button on the faceplate of the QX-5 Twenty will illuminate the button indicating the headphone outputs of the unit are active. The display will temporarily show `PHONES OUT` after pressing the button. While the headphone outputs are active, the main XLR and RCA outputs on the QX-5 Twenty will be muted.

To re-activate the main outputs, press the left-hand button again. This will both mute the headphone outputs and activate the main outputs on the QX-5 Twenty. The button will no longer be illuminated and the display will temporarily show `MAIN OUT`.

## Word Clock Output

Some digital products have word-clock inputs and provide higher performance when supplied with a high-quality external word clock. The word clock output in the Ayre QX-5 Twenty is derived from the ultra-low phase-noise master clock built into the unit.

## AC Power

---

The QX-5 Twenty may be plugged directly into an unswitched wall outlet. Although proprietary RFI (radio-frequency interference) filtering is built into the product, in some situations an AC power-line filter (such as those offered by Ayre) may provide additional sonic benefits.

## AyreLink Ports

---

*AyreLink connections are made with commonly available two-line telephone line cords using modular (RJ-11) connectors. (These are the cords that connect the telephone set to the wall in many countries.) They are readily available in different lengths and various colors at most electronics stores.*

AyreLink



*The linked components may be joined in any convenient order.*

The AyreLink communication system provides a convenient way to control your audio system. There are two AyreLink ports on the rear panel of the QX-5 Twenty. Each port has four contacts and contains both an input and an output. Both ports function identically and may be used interchangeably.



**Be sure to use two-line telephone cords to make AyreLink connections. These can be identified by the four gold contacts on each connector.**

The linked components should be connected in daisy-chain fashion, connecting each component to another until all of the linked components have been connected. Be careful not to connect the two ends of the chain. Closing the chain to form a loop will cause the AyreLink system not to function.

# Configuration

---

Your QX-5 Twenty offers a high level of flexibility in terms of setup. The following information will allow you to configure the unit in the best way for your system and its use.

## Setup Menu

---

*While navigating the Setup Menu, the buttons immediately to the left and right of the display may be illuminated in red (left-hand button) or green (right-hand button) when they are an available choice. If they are not available as a choice, these buttons will not be illuminated.*

In order to change settings or customize your use of the QX-5 Twenty, you'll need to access the Setup Menu.

- 1) Ensure the unit is in System Sleep Mode by holding down the button on the right-hand side of the display for three seconds. A green light will illuminate the silver button and the display will go blank.
- 2) Hold down the left-hand button for three seconds.
- 3) The words `SETUP MENU` will appear briefly on the display, then the words `MAIN INPUT` will be shown.

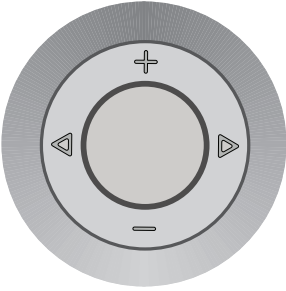

From here you have access to the Setup Menu. You can scroll (using the right and left arrows of the control ring) between menu options in the menu. To select a sub-menu press the green button and to exit a sub-menu press the red button. If an option to select is available, the right-hand button will be illuminated. If the right-hand button is not illuminated, you have reached the end of the selected sub-menu and your only choice will be to exit the sub-menu by pressing the left-hand button.

## Setup Menu Structure

---

Below are diagrams of the QX-5 Twenty's menu structure. These can be used as a reference as to how the menu works and where each section is located within the larger structure.

### QX-5 Main Menu:

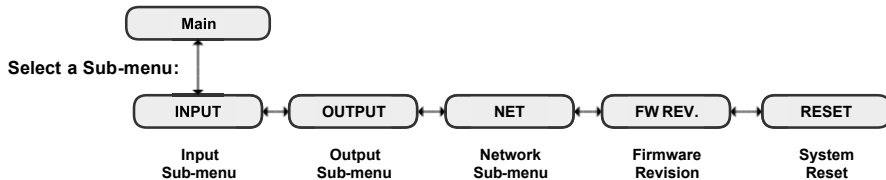

**Input Sub-Menu:**

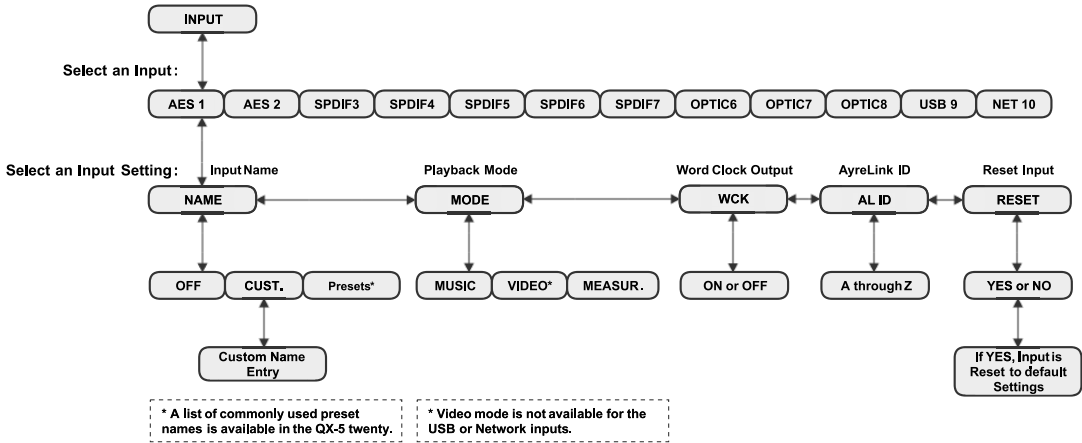

**Network Sub-Menu:**

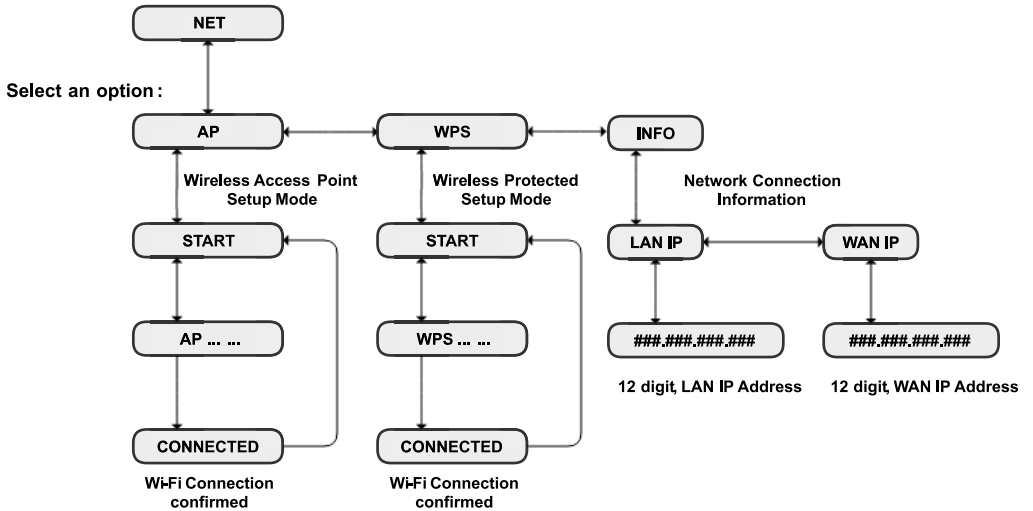

**System Reset:**

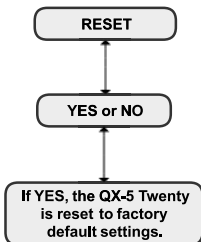

**Output Mode Sub-Menu:**

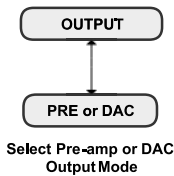

**Firmware Revision:**

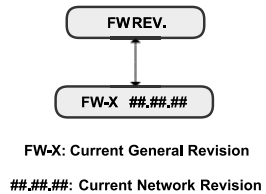

## Firmware Updates

---

Firmware updates may be made available for the QX-5 Twenty. These updates may provide new features and/or improve the use and reliability of your unit. There are two types of firmware updates that are available for the QX-5 Twenty.



**Do not turn off the QX-5 Twenty while updates are in progress.**

## Network Updates

---

Network updates only affect the Ethernet module. Whenever the QX-5 Twenty is turned off and then back on again, the installed network device will connect with the Ayre web server to check for a network update. If one is available, the unit will show the word `UPDATE ?` in the display. Choose either yes by pressing the right-hand button (illuminated green) or no by pressing the left-hand button (illuminated red). If you press the right-hand button, the update will begin and the word `UPDATING` along with numbers (`5...!0...!5...etc.`) will appear on the display, showing the progress of the update until complete, when the display will read `UPDATE DONE`. If you press the left-hand button, the update will not begin, but will prompt you as above every time you turn the unit off and then on again, until the update has been completed.

## General Updates

---

General updates affect the firmware for the unit's operating system, display, digital filters, etc. The general firmware of the QX-5 Twenty may be updated for ease of use and reliability. The unit's firmware version can be found by accessing the Setup Menu, see (pg. 10).



1) Enter the Setup Menu, from *MAIN INPUT*, scroll to the right (using the right arrow on the control ring) until you see *FW REV*.

2) Press the right-hand button and the firmware version will be displayed.

3) If the QX-5 Twenty's firmware version does not match the version available at [www.ayre.com/qx5\\_support.htm](http://www.ayre.com/qx5_support.htm), then download the new version from the website to your computer using the link on the page.

4) Copy the newest version of the firmware to the root directory of your USB flash drive.

5) Find the rocker switch on the back panel of the unit and switch it to "OFF".

6) Insert the USB flash drive into the port labeled "Firmware Update" on the back panel.

7) Turn the rocker switch on the back panel of the unit to "ON". The firmware update will commence automatically. While the unit is updating itself, left-hand button will be



Firmware  
Update



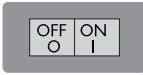

illuminated red. When complete, the unit will return to system-sleep mode.



8) Return the unit to operation mode by pressing the right-hand button.

## Main Outputs

---

The QX-5 Twenty can be switched between preamplifier mode and DAC mode. The preamplifier mode enables an internal digital volume control, allowing use directly into a power amplifier or powered loudspeakers. DAC mode bypasses the volume control, delivering a full-level signal at the outputs for use with systems that already have a volume control (e.g., in a preamplifier).

### DAC and Preamplifier Mode

---

DAC mode bypasses the digital volume control of the QX-5 Twenty and sends a full-level signal to your preamplifier or integrated amplifier. Now your preamplifier or integrated amplifier controls the volume of the system.



**Engaging DAC mode will cause the QX-5 Twenty to output full-level signal. You could cause damage to your speakers if it is connected directly to an amplifier without a volume control.**



Preamplifier mode allows the use of the unit as a digital preamp. Please note that the level of the volume control is retained separately for the preamplifier outputs and the headphone outputs.

## Choosing Main Output Modes

1) Access the Setup Menu, see (pg. 10). You will see the words `MAIN INPUT` on the display.



2) Press the arrow on the right-hand side of the control ring once. The words `MAIN OUTPUT` will be displayed.



3) Press the right-hand button once. The current output mode will be displayed and the display will either read: `MODE DAC` or `MODE PRE`.



4) Using the right- and left-hand arrows on the control ring allows you to scroll between modes.

5) Once the mode you wish to engage appears on the display, press the left-hand button twice to exit the menu.

## Digital Inputs

The Ayre QX-5 Twenty provides virtually every type of digital input available.



## AES/EBU Inputs (1 and 2)

Connect your source to one of these inputs. Please ensure you're using a cable rated for the transmission of a digital signal (110 ohm).



## S/PDIF Inputs (3, 4, and 5)

Connect your source to one of these inputs. Please ensure the cable you're using is terminated with a BNC type connector or adapter. Maximum performance will be attained when using cables with 75 ohm BNC terminations and 75 ohm cabling. Ayre includes BNC-to-RCA adapters for convenience, but the typical impedance of an RCA connector is roughly 30 ohms and will degrade the performance slightly by creating reflections which can increase the jitter.



## Optical Inputs (6, 7, and 8)

Connect your source to one of these inputs with a high quality optical cable.



## USB Input (9)

The USB input uses the square "B" type connector designed for computer peripheral devices. The rectangular "A" type connector at the other end of the cable plugs directly into the computer. The maximum recommended

*If the Network input name is set to OFF in the setup menu, the network module will be disabled and powered off, potentially improving sound quality of other inputs due to reduced electrical noise, but the QX-5 will no longer be seen on the network.*



*Please note that the maximum length of Ethernet cable is 100 meters (328').*

*Any USB flash drive will need to use a FAT32 or NTFS file format in order to be recognized.*

cable length is 10 feet (3 meters). It is not recommended to use extenders or hubs with the QX-5 Twenty. For proper configuration of the USB input on the QX-5 Twenty, please see our computer audio setup page [www.ayre.com/usb.htm](http://www.ayre.com/usb.htm).

## Ethernet Input (10)

---

The Ethernet Input on the QX-5 Twenty will immediately attempt to communicate with your home network as soon as it is physically connected. The unit will appear on your network as “Ayre QX-5” and can be controlled with any UPnP control app.



If the QX-5 Twenty does not appear on your network, please refer to the troubleshooting section, see Network (pg. 44).

The Ethernet input utilizes a ubiquitous Ethernet cable terminating in four pairs of copper wire with a locking end connector. Extended lengths of cable may be used for longer runs if your home network is not in close proximity to the chosen location of the QX-5 Twenty.

There are also two USB “A” ports provided as part of the Ethernet module. The ports may be used to connect the supplied Wi-Fi antenna or a USB flash drive. Music on the USB flash drive can be streamed to the QX-5 Twenty directly via this connection using the mconnect control app.



If you are using the included Wi-Fi antenna to connect the QX-5 Twenty to your network, please see the instructions for “Connecting Wirelessly” below.

## Connecting Wirelessly

---

*Wireless Ethernet connections are not as reliable as wired Ethernet connections. If you are experiencing unreliable wireless Ethernet connectivity, please try locating your Wi-Fi router closer to the QX-5 Twenty.*

The three methods below will allow you to connect to your home network via Wi-Fi, without the need for a physical connection between the QX-5 Twenty and your Wi-Fi router.

A wireless connection is not optimal for high performance. For a higher level of performance, connect your router to the QX-5 Twenty with an Ethernet cable.

### AP Mode

---

AP mode will initiate and authenticate the QX-5 Twenty’s Wi-Fi communication protocol so that it is wirelessly connected to your network. Before commencing the sequence of instructions for AP mode, please ensure you’ve downloaded the mconnect control app, see Apps (pg. 31).

1) Turn the QX-5 Twenty off via the rocker switch on the rear panel.

2) Insert the included Wi-Fi antenna into one of the USB Host connectors.



USB Host





**Ensure NO Ethernet cable is connected.**



3) Turn the QX-5 Twenty on via the rocker switch on the rear panel. The unit will now enter System Sleep Mode.



4) Enter the Setup Menu by holding down the left-hand button until *MAIN INPUT* is displayed.

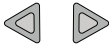

5) Scroll to *MAIN NET* by using the right or left arrows on the control ring on the right-hand side of the faceplate.



6) Press the right-hand button. The screen will now display *NET AP*.



7) Press the right-hand button. The screen will now display *AP START*.



8) Press the right-hand button. The display will now show moving dots, indicating that AP Mode is engaged.

9) Using your phone/tablet, find the wireless network “Ayre QX-5” on its list of available networks.

10) Enter the QX-5 Twenty’s network password, which is “password”.

11) Turn on the mconnect app.

- 12) Go to Settings (  symbol left hand corner).
- 13) Select “Device Setup” from the menu.
- 14) Select “Ayre QX-5” from the device list.
- 15) Select “Wi-Fi network selection.”
- 16) Find your home network on the list.
- 17) If your home network requires a password, enter it at this time.
- 18) The QX-5 Twenty will automatically join your home network. Once the connection to the network is made, the display will read `CONNECTED`. (This may take 10 - 15 seconds)
- 19) The display will then revert to `NET AP`.
- 20) Now press the left-hand button until you’ve exited the Setup Menu, or until you reach the next item you would like to configure.

## WPS Mode

---

*Not every router or modem is capable of WPS mode, please check your router’s manual for this feature.*

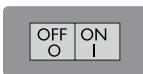

WPS (Wi-Fi Protected Setup) allows you to easily connect your QX-5 Twenty to your home network, without the use of an Ethernet cable.

- 1) Turn the QX-5 Twenty off via the rocker switch on the rear panel.

2) Insert the included Wi-Fi antenna into one of the USB Host connector.



**Ensure NO Ethernet cable is connected.**



3) Turn on the QX-5 Twenty via the rocker switch on the rear panel.



4) Enter the Setup Menu by holding down the left-hand button until `MAIN INPUT` is displayed.

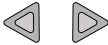

5) Scroll to `MAIN NET` by using the right- or left-arrows on the control ring on the right-hand side of the faceplate.



6) Press the right-hand button.



7) Using the right or left arrow on the control ring, scroll to `NET WPS`. Press the right-hand button. The front panel display will now read `WPS START`.



8) Press the right-hand button. WPS mode will now be engaged. The unit will be in this mode until it connects to your router, or until you exit this menu by pressing the left-hand button once.

9) At this point you will need to press the WPS button on the back of your home network router, or follow its instructions to initiate WPS, or Wi-Fi Protected Setup mode.

10) Once the wireless link has been created, the display of the QX-5 Twenty will read **CONNECTED**. The display will then revert to **NET WPS**.



11) Now press the left-hand button until you've exited the Setup Menu, or until you reach the next item you would like to configure.

## Wire-Aided Wi-Fi Connection

*These instructions allow you to connect to a password protected, non-WPS enabled, wireless router.*

This connection method requires that you temporarily use an Ethernet cable to authenticate communication between your QX-5 Twenty and your home network. Afterwards you may disconnect the cable and place the QX-5 Twenty in its permanent location.

Before beginning, please download the mconnect control app, see Apps (pg. 31).

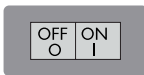

1) Turn off the QX-5 Twenty via the rocker switch on the rear panel.



2) Make sure the Ethernet cable for your network is connected to the port in the back of the unit.



3) Insert the included Wi-Fi antenna into one of the USB Host connectors.



4) Turn on the QX-5 Twenty via the rocker switch on the rear panel.





- 5) Press the right-hand button to bring the unit out of System-sleep mode.
- 6) Access the mconnect control app through your phone or tablet.
- 7) In the mconnect app, go to its Settings Menu (  symbol in the left-hand corner) select “Device Setup”.
- 8) Select “Ayre QX-5” from the device list.
- 9) Select “Wi-Fi network selection.”
- 10) Find your home network on the list and select it.
- 11) Type in your home network password. A notice will appear on your phone/tablet, indicating: “The device is attempting to connect to the network”. Press OK.
- 12) Disconnect the Ethernet cable, now the unit will connect via the wireless network.

## IP Address

---

- 1) Access the Setup Menu, see (pg. 10). You will see the words *MAIN INPUT* on the display.
- 2) Press the arrow on the right-hand side of the control ring until the words *MAIN NET* are displayed.





3) Press the right-hand button once.



4) Using the right-hand arrow on the control ring will allow you to scroll to the word `INFO`.



5) Press the right-hand button once.



6) Using the right-hand arrow on the control ring will allow you to scroll between `WAN` and `LAN`.



7) Select which IP address you'd like to see displayed and press the right-hand button once.



8) The display will now show the IP address of the QX-5 Twenty. Make a note of it and exit the sub-menu by pressing the left-hand button.

# Operation

---

The following chapter contains information on the controls available for your QX-5 Twenty. These are available from the faceplate, the remote control handset, and various software applications.



## Off / On (0/1)

---

*System-sleep can reduce power consumption in AyreLink connected power amplifiers when not listening to music.*

The main power switch for the QX-5 Twenty is a rocker on the rear panel. This switch disconnects the unit completely from the AC power. When the unit is turned “off”, none of the auxiliary functions (e.g., the AyreLink system communication and Ethernet input) are operable. Once the QX-5 Twenty is turned “on”, it may take 30 minutes to fully warm up and sound its best. A System-sleep option is available, this allows auxiliary functions to operate and minimizes warm-up time by keeping power applied to the audio circuitry, see (pg. 28).

## Control Ring

---

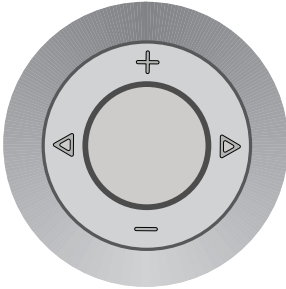

The control ring on the right-hand side of the faceplate has two functions during normal operation. The arrow symbols scroll between inputs with the left- and right-hand arrows, and change volume level with the +/- buttons at the ring's top and bottom.

## Volume Control

---

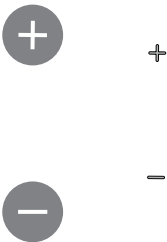

The volume level may be controlled with the +/- buttons on the control ring or the remote control handset. The volume level is indicated on the front panel display. There are 100 individual levels, each with a step size of 1.0 dB, allowing for precise selection of the desired volume setting.



If the volume control is advanced beyond the highest available level, the front panel will briefly display the message **MFX**.

## Input Select

---

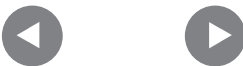

The desired source component may be selected with the right- and left-facing arrows on the control ring (to the right of the display) or the remote control handset, and the assigned name is displayed on the front panel.

## Mute / System-sleep mode

---



The right-hand button on the QX-5 Twenty serves two functions; mute and control of the Low-Power function.

### Mute

---



A short press of the right-hand button (or the dedicated button on the remote handset) provides an easy way to temporarily turn the volume of the QX-5 Twenty to “zero” while retaining the current volume setting in memory. Pressing either button a second time restores the volume to the previous level.



### System-sleep mode

---



Press and hold the right-hand button for three seconds (or a short press of the “1/0” remote button) to enter the system-sleep mode. All connected AyreLink-equipped components will enter a low power consumption state, yet the AyreLink functions remain active. This mode is indicated by illuminating the green LED in the right-hand button.



A long press of the “1/0” remote button will place all AyreLinked components into low-power consumption or standby mode. A short press of the button will put the QX-5 Twenty into sleep mode and not affect any other components.

## Front-panel Display

---

The display of the QX-5 Twenty has the ability to display extra information about some of your recordings.

### Display Brightness

---



The brightness of the front-panel display may be controlled via the remote control. There are three brightness levels and a “display off” setting. Each press of the remote control button scrolls through the available brightness settings.

A blue LED on the unit indicates when the display is turned off. When further commands are received, either from the front-panel buttons or the remote control, the normal display is activated for a few seconds to confirm the command, and then the display turns off again.



Changing the display brightness of components linked via the AyreLink communication system also changes the display brightness of all linked components.

## Recording Indicators

---

The QX-5 Twenty has the ability to provide you with information about different types of HDCD and pre-emphasized recordings.

## HDCD Indicators

---

There are different types of HDCD recordings. Below are the different indicators which may be displayed during playback.

1) Green LED in the right side of the display window.

This will mean that a Pacific Microsonics analog-to-digital converter was used in the making of the recording. There is no actual HDCD decoding taking place if only the green LED is illuminated in the display window. This is not a true HDCD recording.

2) Green LED, plus the letters **HD** in front of **CD** on the display are illuminated.

This means you're listening to an actual HDCD recording and that HDCD encoding is being decoded.

## Pre-emphasis Indicators

---

The letters **PRE** in front of the sample rate on the right-hand side of the display.

This means that a track has been detected which was recorded with pre-emphasis and the proper de-emphasis EQ is being applied.

## Remote Handset

---

*Top half of the remote operates the QX-5 Twenty.*



*Bottom half of the remote operates an analog Ayre preamplifier or integrated amplifier.*

The provided remote control handset will operate both the Ayre QX-5 Twenty as well as an Ayre preamplifier or integrated amplifier.

### Battery

---

The remote handset uses one CR2032 coin cell. It is accessed by pulling the plastic tab and opening the cover on the back/bottom of the remote.

## Network Connection and Control

---

In addition to the Ethernet input, the QX-5 Twenty offers additional methods of connection for the control and streaming of music. Utilizing the included Wi-Fi antenna to either stream music from a phone or tablet requires that you download the mconnect control app from the app store.

### Apps

---

Once you've connected an Ethernet cable from your home network to the QX-5 Twenty via the Ethernet input, your network will be able to "see" the unit. In order to make use of the network-



and internet-streaming features included with the QX-5 Twenty, you must first download the control and support app from your app store. Finding the app is best done by locating the “search” field in your app store and using the search terms: “mconnect control.” The first, or only search result should be the mconnect control app, published by ConversDigital Co., Ltd.



If you’re using a tablet, installing the app named “mconnect control HD” allows alternating between portrait mode to landscape mode.

## Generic UPnP Apps

---

While the mconnect control app is the only app created specifically for the QX-5 Twenty, other UPnP control apps will also work. Searching for: “UPnP control apps” in your app store will provide you with a list of many. The QX-5 Twenty is designed to the UPnP standard and the majority of UPnP apps should operate it. If you have a problem with a specific app, please contact the specific publisher of the app in question.

## Roon

---

Roon is an advanced and powerful software application capable of relating, organizing and playing back a large digitally stored music collection. As shipped from the factory, the Ethernet input of your QX-5 Twenty is a “Roon Ready Endpoint.” This means you’ll have access

to all of your music for playback through the QX-5 Twenty. If you are already using Roon or are interested in using it, please go to Roonlabs.com for instructions on doing so.

## Online Streaming Services

It's important to note that if you want to make use of online streaming services such as Tidal and Deezer, you will need to download the mconnect control app. These services may charge for a subscription separately. You will be prompted to sign into your account from the mconnect control app. Ensure you have the log-in information ready when starting the app for the first time.

## Spotify Connect

*Spotify service can only be accessed through the Spotify app.*

In order to begin listening to music through Spotify Connect on the QX-5 Twenty, you will need to ensure you are a Spotify Premium subscription holder. Simply turn on the Spotify app on your phone, tablet, or desktop/laptop computer. Once turned on, the Spotify app will "see" the QX-5 Twenty as a device available for playback on your network. Instruct Spotify to stream music to the unit and music should commence immediately.

# Customization

---

The Ayre QX-5 Twenty offers many customizable options. It is configured at the factory to provide the best performance for a typical installation. However, in certain situations you may wish to change the default configuration to fit your system.

## Modes of Operation

---

The Ayre QX-5 Twenty offers three distinct output modes depending on the intended usage. Please select the mode that best suits your system and needs.

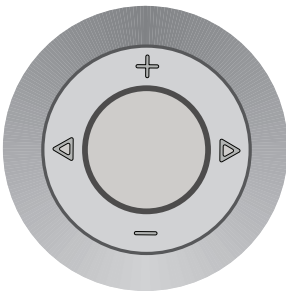

### Digital Preamplifier

---

The QX-5 Twenty will come from the factory with this setting as its default output mode. You may immediately begin using the + and – buttons (top and bottom) on the control ring to the right-hand side of the faceplate. Simply connect XLR or RCA interconnect cables from the rear panel

Analog Audio Output connectors directly to an amplifier of your choosing.

## Digital-to-Analog Converter (DAC)

In order to use the QX-5 Twenty as a digital source component without volume control, enter the Setup Menu, see (pg.10) and select (by scrolling once to the right) **OUTPUT** from the Main Menu. Then select **DAC** (as opposed to **PRE**) from the mode menu. Once **DAC** is selected, press the left-hand button until you have exited the Setup Menu. This mode is called “DAC mode.” Once engaged, volume control is fixed at maximum output level and will not be variable.



**The output of the unit will be at full volume in DAC mode and could cause damage to stereo systems that have no other volume control in the signal path after the QX-5 Twenty.**

## Headphone Amplifier

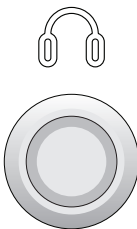

The QX-5 Twenty is equipped with a world-class headphone amplifier. Headphones can offer a more intimate listening experience. In order to use this function, simply connect a set of headphones to the front of the unit under the display, and press the button (to the left of the display) with a headphone icon engraved above it. Once pressed, the LED surrounding this button will be illuminated in red, the Headphone Outputs will

*For more information on the available headphone outputs refer to the “Headphone Output” section, (pg. 7).*

become active, and the Analog Audio Outputs from the rear panel of the unit will be muted. In order to re-engage the Analog Audio Outputs, simply press the headphone button once again. This will mute the headphone output (but will remember the last volume level you were using) and flow of signal from the Analog Audio Outputs on the rear panel will resume.

## Disabling Inputs

---

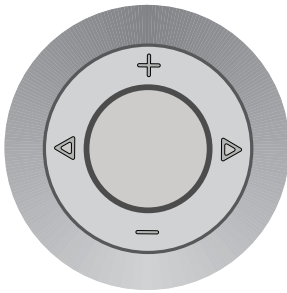

Use of the QX-5 Twenty may be streamlined if all unused inputs are disabled in the Setup Menu.

- 1) Once in the Setup Menu, the first choice available will read `MAIN INPUT`. Select this option by pressing the right-hand button on the right-hand side of the display. The input name and number (`INPUT XXX ▣`) will be displayed.
- 2) Scroll to the desired input by pressing the right and left arrow buttons on the control ring. Once the desired input is shown on the display (`INPUT XXX ▣`), press the right-hand button on the right-hand side of the display.
- 3) The input name and number (`XXX ▣ NAME`) will be displayed. Press the right-hand button once more.
- 4) The name and number (`NAME XXX ▣`) of the input will be displayed.



5) Scroll left or right by pressing the right and left arrow buttons on the control ring until the display shows the word `FFF`.



6) You may press the left-hand button once to scroll through more inputs you may want to disable, or exit the Setup Menu by pressing the left-hand button on the left-hand side of the display four times.

## Naming Inputs

---

*You will have five character fields available for establishing your custom name.*

Once all inputs have been connected, it may be desirable to label selected inputs with a custom name for greater ease of use.



**Please note that the custom name you choose will only appear during normal operation. While using the setup menu, the original input name will be displayed.**

## Custom Names

---



1) Once in the Setup Menu, the first choice available will read `MAIN INPUT`. Select this option by pressing the right-hand button on the right-hand side of the display. The input name and number (`INPUT XXX 0`) will be displayed.



2) Scroll to the desired input by pressing the right and left arrow buttons on the control ring. Once the desired input is shown on the display (INPUT XXX X), press the right-hand button on the right-hand side of the display.



3) The input name and number for the input (NAME XXX X) will be displayed to the right-hand side of the display. Press the right-hand arrow on the control ring twice so that the display reads: NAME CUST.



4) Press the right-hand button on the right-hand side of the display. The display will now read: CUST.



5) Begin scrolling through possible character choices by pressing the + / - buttons at the top and bottom of the control ring. The blinking dot “.” will indicate the selected character field.



6) Once the desired character is displayed, simply press the right arrow button on the control ring to move the blinking dot to the next character field.



7) Now press the left-hand button until you've exited the Setup Menu, or until you reach the next item you would like to configure.

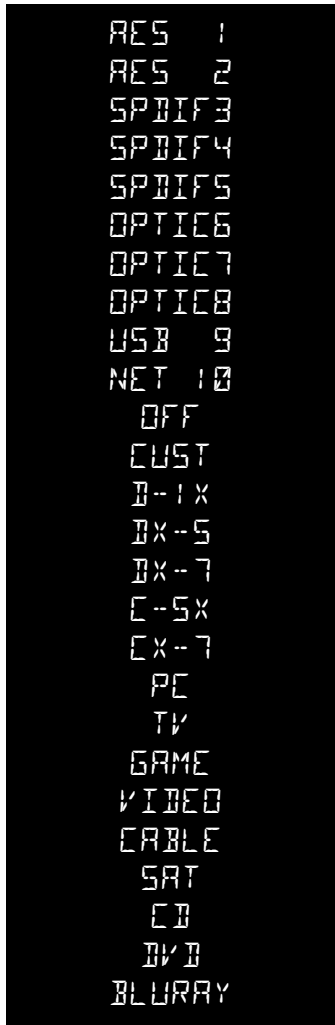

## Preset Names

---

- 1) Enter the Setup Menu, see (pg. 10).
- 2) The display will show `MAIN INPUT`. Press the right-hand button.
- 3) The left-hand side of the display will read `INPUT`. The right-hand side of the display will show the inputs you may select for re-naming.
- 4) Scroll through the input choices by pressing the right- or left-hand arrows on the control ring.
- 5) Once you've scrolled to the input name you'd like to change, press the right-hand button.
- 6) Now you will see the default input name on the left-hand side of the display. On the right-hand side, the word `NAME` will be displayed. Press the right-hand button to enter the name selection sub-menu.
- 7) Now the word `NAME` will appear in the left-hand side of the display and the default name of the current name setting will be displayed.
- 8) Now scroll through the possible input names by pressing the left- and right-hand arrows on the control ring.
- 9) Once you see the preset name you'd like to use, press the left-hand button to leave that sub-menu.





## Audio Modes

---

The Ayre QX-5 Twenty has three different audio modes. You may wish to select an alternate mode in certain circumstances. The unit ships in “Music Mode.” Below you’ll find a description of the three modes, followed by instructions for changing the currently selected mode. The Mode options are not universal, each input is set individually.

### Music Mode

---

The QX-5 Twenty will ship from the factory with “Music Mode” as its default setting. The Music Mode uses a large buffer for the digital audio data, completely eliminating jitter even for inputs where the data flow is controlled by the source.

### Video Mode

---

*The video mode option is only available for the S/PDIF-based inputs (1 - 8).*

The data buffer used for Music Mode may cause noticeable delay issues between audio and video when watching video sources. The Video Mode bypasses the data buffers, ensuring perfect audio/video synchronization when watching video sources.

## Measure Mode

---

This digital filter uses an algorithm which produces greater accuracy in the frequency domain. Some listeners may prefer the additional high-frequency energy provided by this mode, but most will derive a greater sense of musical enjoyment from “Music Mode.”

## Changing Audio Modes

---



1) Enter the Setup Menu, see (pg. 10) and select **MAIN INPUT** using the right-hand button.



2) From the **MAIN INPUT** menu, scroll to (using the right- or left-arrows on the control ring), then select the input (press the right-hand button) whose audio mode you would like to change.



3) The input's menu will now be selected. Scroll to the right once until you see the word **MODE**. Press the right-hand button.



4) Now the **MODE** menu will appear. The current mode will read in the display. Scroll to the desired mode.



5) Now press the left-hand button until you've exited the Setup Menu, or until you reach the next item you would like to configure.

# Specifications

---

*Audio Inputs*      USB: 44.1, 48, 88.2, 96, 176.4, 192, 352.8,  
384 kHz  
PCM 16, 20, 24 bits  
DSD64 and DSD128 (as DoP)

Optical/SPDIF/AESEBU: 44.1, 48, 88.2, 96,  
176.4, 192 kHz  
PCM 16, 20, 24 bits  
DSD64 (as DoP)

Network: 44.1, 48, 88.2, 96, 176.4, 192 kHz  
PCM 16, 20, 24 bits  
DSD64 (as DoP)

*Line output level*      4.0 Vrms balanced, 2.0 Vrms single-ended

*Headphone output level*      8.0 Vrms balanced, 4.0 Vrms single-ended

*Power Consumption*      60W

*Dimensions*      17.25" W x 13.00" D x 3.75" H  
44 cm x 33 cm x 10 cm

*Weight*      16 pounds  
7.25 kg

In Case of

# Trouble

---

In the event that you experience any technical difficulties with your QX-5 Twenty, the following items may help to solve the problem or track down the cause.

## Display Faults

---

*If any of these fault persists,  
contact the Ayre dealer for  
service.*

The Ayre QX-5 Twenty will display faults when a problem occurs. The following faults are listed, along with possible solutions to the problem.

### Fault A/C

---

If the display shows **FAULT A/C** this is an undervoltage AC mains condition. The fault should clear itself automatically, or the unit will lose power. Restart the QX-5 Twenty.

## Update Error

---

If the display shows `UPDATE ERROR` there was an error during the network update process (Update interrupted by power failure or network failure). Restart the unit.

If the network module is no longer responsive, then the update failure caused the module to fail and it will need to be replaced. Contact the Ayre dealer for service.

## Network

---

If the QX-5 Twenty cannot be seen as a device on your home network follow this procedure.

If you're using an Ethernet cable, turn the unit off. Verify that the Ethernet cable is attached to the Ethernet port on the rear panel of the unit, and that the cable is connected to a router on the network. Turn the QX-5 Twenty back on. Ensure the `NET` input is enabled (not set to `OFF`) in the setup menu. If the problem persists, restart your router. If it is not solved by restarting your router, contact the Ayre dealer.

If you're using Wi-Fi, follow the steps in the manual for connecting wirelessly and ensure that the unit is connected to your local wireless network. If these steps are followed and the unit still cannot be seen, restart the QX-5 Twenty. If

the problem persists, the Wi-Fi antenna may need to be replaced.

## Streaming

---

If the control app can't stream to the QX-5 Twenty over the network (or reports an error when trying to connect) follow these steps.

First, go to the *F/W REV* sub menu and confirm that the six-digit firmware revision is up to date (current revision number will be available at [www.ayre.com/qx5\\_support.htm](http://www.ayre.com/qx5_support.htm)).

If it is not up to date, turn the QX-5 off, then bring the unit out of system sleep mode and wait for the *NET UPDATE?* prompt to appear. After updating, the F/W revision should be up to date.

Next, check that no other applications are also trying to stream to the QX-5 Twenty. If an application is already streaming, the unit will not let another application take control.

Then, ensure that the streaming application being used is supported by checking the QX-5 support page [www.ayre.com/qx5\\_support.htm](http://www.ayre.com/qx5_support.htm). Lastly, restart the unit.

If the problem persists, contact the Ayre dealer for service.

## USB Connection

---

If the QX-5 Twenty appears as “Unknown USB device” when connected to a computer. Check that your drivers are installed correctly, and up-to-date. Instructions for this can be found at [www.ayre.com/usb.htm](http://www.ayre.com/usb.htm).

## Other Connected Products

---

The Ayre QX-5 Twenty will display error messages from connected AyreLink equipped power amplifiers, simplifying the task of system troubleshooting.

## Overheating

---

*If overheating occurs, be sure to correct the cause before continuing to use the amplifier.*

If a power amplifier is operated at high playback levels with insufficient ventilation, the internal temperature may become too high, triggering the thermal protection circuitry.

The QX-5 Twenty’s display will change to read **AMP HOT** if an AyreLink equipped power amp is connected and its temperature becomes too high.

Once the unit has cooled, the amplifier may return to normal mode. The **AMP HOT** message

will remain visible on the QX-5 Twenty so that the source of the error is known.



To restore the unit to its normal operating mode, simply press the right-hand front-panel button.

## Rail Fuses

---

Internal power supply fuses protect both the loudspeakers from excessive current and the amplifier from short-circuits. If any of these fuses fail, the amplifier will not operate.



The input selector characters will change to read `AMP FUS` when one of the internal fuses of a connected AyreLink equipped power amplifier fails.

The amplifier must be completely disconnected from the AC power to replace the fuses.



**Do not remove the amplifier cover. Hazardous voltages may exist inside the unit. Please refer fuse replacement to a qualified service technician.**

## AC Line Voltage

---

If the AC line voltage drops below 85% of normal (brown-out), Ayre products will go into protection and the unit will not operate.





The QX-5 Twenty display will change to **AMP AC LOW** when the AC line voltage is too low.

When the AC line voltage returns to normal the **AMP AC LOW** message will remain so that cause of the error is known. Press the right-hand front-panel button to return the unit to the operate mode.

*If there are any unusual noises coming from the loudspeaker, turn the rear-panel AC power switch to “Off” immediately. Please return the unit to your authorized dealer or service center.*

## DC Offset

---

AyreLink equipped power amplifiers incorporate a circuit to detect the presence of DC at the output terminals which could be harmful to the loudspeaker.



The QX-5 Twenty display will change to read **AMP DC OFFSET** when excessive DC offset is present.

Disconnect the source component that caused the error from your system. Then press the right-hand front-panel button to return the unit to the normal operate mode and select a different source component. If the system operates properly in this case, take the faulty source component to an authorized dealer or service center.

# Warranty

---

## North American Warranty

The Ayre QX-5 Twenty digital hub is warranted against defects in materials and workmanship for a period of ninety days from the date of original purchase. This ninety-day coverage is automatic upon acceptance of delivery and no registration is required.

Additionally you have the option, at no cost, to extend the warranty for a period of five years from the date of purchase by returning the completed Warranty Registration Card and a photocopy of your original purchase receipt in the enclosed postage-paid envelope to Ayre within thirty days of product delivery. This optional warranty is only available within the thirty-day registration period.

## North American Warranty Statement

---

1. If any defects are found in the materials or workmanship of this Ayre product within the warranty period, the unit will be repaired or replaced by Ayre Acoustics, Inc. (Ayre) or its authorized agent.

2. Purchaser must return the product, packed in the original shipping carton, freight prepaid to:

Ayre Acoustics, Inc.  
2300-B Central Avenue  
Boulder, Colorado 80301

or to Ayre's authorized agent. The product must be accompanied by a written description of the defect and a photocopy of your original purchase receipt.

Ayre will not be responsible for any shipping damage and strongly recommends the purchase of shipping insurance.

3. Ayre reserves the right to inspect any product that is the subject of any warranty claim prior to repairing or replacing it. Final determination of warranty coverage lies solely with Ayre. Out-of-warranty claims will be billed for labor, materials, return freight, and insurance as required.

Any product for which a warranty claim is accepted will be returned to the purchaser and

the cost of shipping and insurance will be factory prepaid within the boundaries of the USA. Units to be shipped outside of the USA will be shipped freight collect only.

4. Ayre strives to manufacture the finest possible equipment, and therefore reserves the right to make improvements on its products, without necessarily assuming any obligation to retrofit such changes upon its previously manufactured models.

5. The above warranty is the sole warranty given by Ayre, and is in lieu of all other warranties. All implied warranties, including warranties of merchantability or fitness for any particular purpose shall be strictly limited to the duration of the above warranty. Ayre shall have no further obligation of any kind, whether express or implied. Further, Ayre shall in no event be obligated for any incidental or consequential damages as a result of any defect or any warranty claim, whether express or implied.

6. Ayre does not authorize any third party, including any dealer or sales representative, to assume any liability of Ayre or make any warranty for Ayre. The unit must not have been altered or improperly serviced. The serial number on the unit must not have been altered or removed.

7. The remaining period of this warranty is only transferable to subsequent purchasers if the product is resold by an authorized Ayre dealer.

## International Warranty

---

Warranty terms outside of North America may vary. Please contact the authorized Ayre distributor in your country of purchase for the terms of warranty and also the service itself.

A Place for

# Notes

---

*Serial Number:*

\_\_\_\_\_

*Purchase Date:*

\_\_\_\_\_

*Dealer:*

\_\_\_\_\_

*Salesperson:*

\_\_\_\_\_



*Ayre Acoustics, Inc.  
2300-B Central Ave.  
Boulder, Colorado 80301*

*[www.ayre.com](http://www.ayre.com)  
+1-303-442-7300*